



Mining

CHANGE®
for Success





All information given is based on our current knowledge and expertise and is supplied without obligations or commitments. This also applies to the patent rights of third parties. Neither do we give any obligatory warranty in the legal sense as to the properties of the products described in this publication. We expressly reserve the right to change our specifications in accordance with technical progress and company developments. This does not release the buyer from his obligation to inspect all incoming products. The quality of all our products is of course guaranteed in accordance with our general terms and conditions of sale.





Contents

THIELE - Company Profile 4-5

THIELE - Drop Forging 6-7

Chain Overview / Range of Chain Grades 8-10

Breaking-Strength Comparison 11

THIELE - Corrosion Protection 12-13

 Tectyl (TEC) 12

 Hot-dip galvanising (TZN) 12

Overview of Round Link Chains 14



THD Round Link Chains DIN 22252 15

TSC Round Link Chains 16

TSD Round Link Chains 17

TRQ Round Link Chains 18

TIP Round Link Chains 19

Overview of Flat Type / DUALINK® Chains ... 20-21



THD Flat Type / DUALINK® Chains 22

TSC Flat Type / DUALINK® Chains 23

TSD Flat Type / DUALINK® Chains 24

TIP Flat Type / DUALINK® Chains 25

Overview of Super Flat Type Chains REINFORCED..26-27



THD / TSC / TSD / TIP / TZN
Super Flat Type Chains REINFORCED .28-29

Overview of BIG-T® Chains 30



THD BIG-T® Chains 31

Overview of BROADBAND Low Profile Chains32-34



BROADBAND Low Profile Chain
grade THD / TIP / TSC32-33



BROADBAND Low Profile Chain
Connectors 34

Overview of Chain Connectors 35

 Flat Type Connectors 36

TKF Connectors  36

 DMK Connectors 37

SP Connectors  37

 SP-S Connectors 38

Power Chain Connectors  39

 PLOWMASTER®-S 39

BLOCKMASTER®  40-41

 BLOCKCHAMPION®42-43

Overview of Flight Bars 44

 S-Type Flight Bars (symmetrical bars)45-47

E-Type Flight Bars (split-type)  48-49

 Single-strand Flight Bars 50

Induction-hardened tips 51

Overview of Outboard Chain Assemblies 52

 Outboard Chain Flight Bars DIN 2225752

Outboard Chain Connectors DIN 2225353

Sprocket Rings / Assemblies 54-57





TM-Chain Blocks  58-59

TM-Lever Blocks  58-59

Cardan Chains  60

Accessories: Pretensometer  60

Accessories: Chain Gauge  61

Accessories: Chain Saw  62



THIELE – company profile

The THIELE company

The THIELE company was founded more than 85 years ago and is now one of the world's leading chain manufacturers. THIELE's product line includes round-link chains, bush conveyor chains, forged conveyor chains and a full range of fittings and accessories. THIELE's know-how has been built up over many years of designing and producing complete chain systems. Our highly skilled workforce and modern, high-performance production facilities stand guarantee for products of the finest quality.

Consulting and product development

THIELE specialises in chain systems for conveying and lifting. THIELE engineers provide an on-site consulting service and work alongside the client to analyse the technical requirements before planning and sizing up the moving chain assembly. Customised solutions are then worked out in detail in THIELE's own design department.

Chain production

All our chains and components are manufactured in-house. Our production facilities include equipment for welding, laser-, plasma- and gas-cutting, solid forming, heat treatment and mechanical processing using the latest CNC lathes and multi-spindle milling machines.

Quality

High-integrity production methods are used to ensure that all products leaving the THIELE factory are of the finest quality, as confirmed by continuous monitoring in our laboratory and testing house. THIELE was one of the world's first chain making companies to meet the DIN EN ISO 9001 quality management standard.

Environment

Our production procedures and processes involve considerable consumption of materials and energy resources. At THIELE we therefore have a special responsibility to continuously improve the environmental compatibility of our products, reduce the consumption of pollutants and simultaneously reduce the use of natural resources in the manufacturing process. Our emergency action plans also ensure that we react appropriately in emergency situations. Environmental protection benefits both the conservation of natural resources and THIELE's continued development. This is why we strive for affordable, environmentally and socially compatible contractual solutions for our products, from their manufacture to their disposal. The continuous improvement of all our production processes combined with a reduction of the environmental impact is an inherent part of our corporate philosophy.

Customs

The increased globalization and the changed global security situation have caused the EU to introduce the status of an "Authorised Economic Operator" (AEO) as a form of effective risk management within the customs administrations. The aim is to secure the continuous global supply chain from the manufacturer to the end-user.

The company THIELE has furnished proof that it is a reliable trading partner and it has already been in possession of an AEO certificate since 2010.



Development, CAD design, chain dimensioning

All product development takes place in our own technical department, where the latest 3D CAD programs are used in the design of mining chains, connectors, flight bars and forging dies. Precise volume calculations enable us to reduce material costs during forging. 3D CAD programs are also used to simulate complex chain routings over sprocket wheels and in conveyor installations.



Production line

THIELE mining products are manufactured at the Iserlohn-Kalthof plant where the facilities include the state-of-the-art welding and bending machines, forging hammers, CNC machines and heat treatment lines.



Service

The company operates a mobile chain testing service whereby accredited technicians are able to carry out chain testing in-situ. We can offer a full inspection program for chain conveyors and also carry out chain wear measurements on request. Specialists are also available to oversee chain assembly and commissioning of your conveyor systems.

Clients can also have their conveyor chains checked for wear, material fatigue and corrosion in our in-house laboratory, thereby providing them with reliable information on remaining chain life.

THIELE – drop forging plant

Forgings weighing between 0.1 kg and 100 kg and measuring up to 1350 mm, are produced on several forging hammers – 16 kJ up to 160 kJ (10 kJ is equivalent to an impact energy of 1 tonne from a 1 m height of drop) – and a 1,600-tonne forging press. The feedstock comprises square billets with edge lengths between 20 and 120 mm or round billets 18.5 to 60 mm in diameter.

The material is first cut to size by cropping or sawing before the individual segments are heated in an induction unit assigned to the respective forging machine. The heated blanks are then reshaped in a die using pneumatically generated impact energy or by a forming force applied via a centrifugal mass. The flash is then removed from the finished piece. The forming process often involves working to extremely fine tolerances.

After forging the components undergo careful heat treatment in order to fine-tune their final properties.

At THIELE we make all our dies and trimming and calibration tools in-house.

We also employ program-controlled machines that can produce shapes using the latest technology, including high-speed milling.



Forging with quality assurance

An experienced workforce combined with reliable production methods are the key to real quality assurance.

All key product characteristics are continuously monitored in a series of elaborate routines that are carried out at THIELE's in-house testing and laboratory facilities.

This includes comprehensive crack testing of all forged chain links.

Benefits:

- all forgings FEM-optimised
- drop forged according to grain direction
- calibrated chain recesses on flight bars
- precise heat treatment and machining

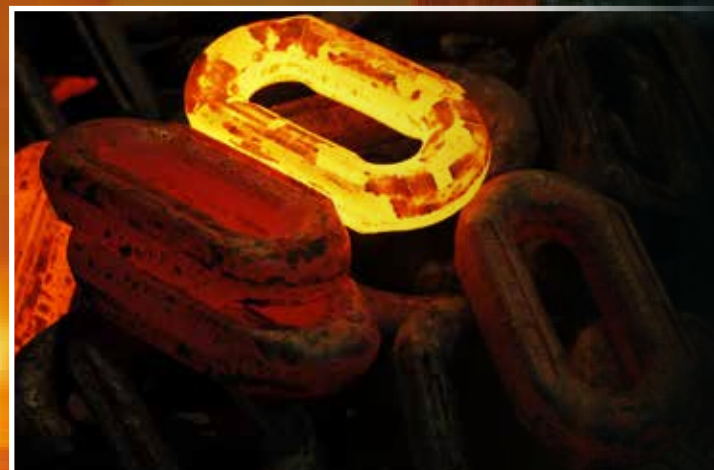



THIELE Chain Overview

To ensure that its products can meet the tough demands of today's mining industry THIELE has developed its own chain steels based on many years of manufacturing know-how.

Each production stage is accompanied by careful and thorough quality control tests. THIELE chains are recognised the world over for their performance and durability.



Round Link Chains
Page 14-19



Super Flat Type Chains REINFORCED
Page 26-29



Flat Type Chains
Page 20-25



BIG-T® Chains
Page 30-31



DUALINK® - Chains
Page 20-25



BROADBAND Chains
Page 32-33



THIELE Chain Overview

One important factor to be considered when it comes to low-height conveyors is that the conveyor chain has to be designed for a minimum headroom requirement (the b_4 dimension). Operators frequently demand the maximum possible chain thickness for a given design height. THIELE's range of chains are graded in ascending order so that the same profile pan can be fitted with the next-largest nominal size (= nominal diameter).

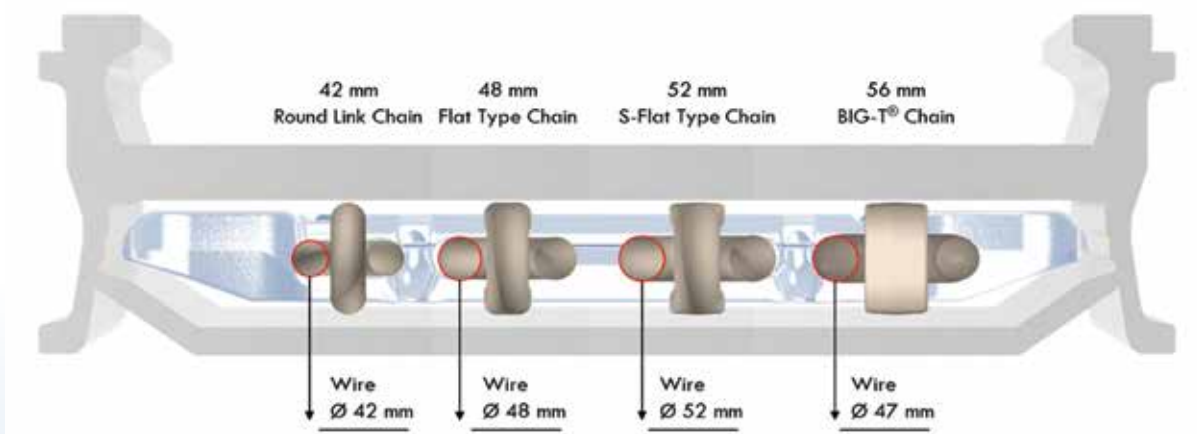

If a larger-size chain is installed in the same profile height the scraper bar will inevitably be weakened in the chain seat. With the BIG-T® chain the round link in the chain seat is tapered so that the scraper bar can retain its critical flight profile.



Bild: mediajff für PG SILESIA



THIELE's range of chain grades

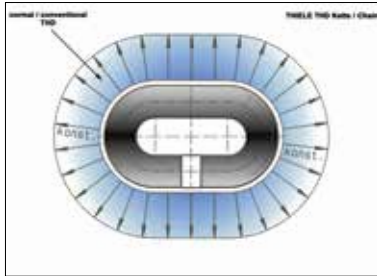

THD (THIELE Heavy Duty)

(Strength: 345 – 375 HB10)

THD Chains are hardened and tempered to a strength of 345 – 375 HB10 (which applies uniformly over the entire link). For chains intended for face conveyors this strength level represents the optimum in terms of impact resistance (notch impact strength) and wear resistance (hardness).

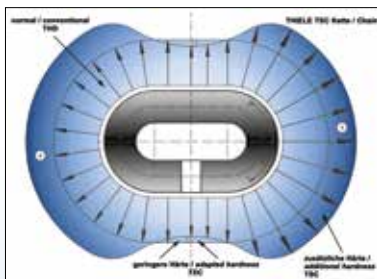

TSC (THIELE Super Crown)

(Strength: Crown 385 – 414 HB10; Leg 345 – 375 HB10)

THIELE developed the TSC Chain series with wear-resistant crowns (THIELE Super Crown) in order to reduce link wear on plough chains and increase chain operating life. THIELE TSC chains are widely used on chain scraper conveyors because of the increased hardness of their crowns.

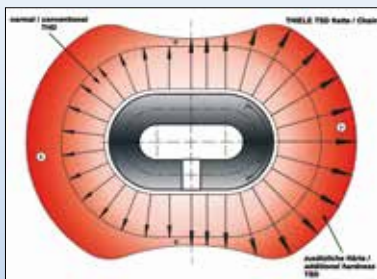

TSD (THIELE Super Duty)

(Strength: Crown 424 - 453 HB10; Leg 345 – 375 HB10)

TSD Chains were developed in order to achieve the greatest possible wear resistance when used on chain scraper conveyors. The material strength of the legs is deliberately reduced by precise heat treatment, which increases the crack arrest capacity in order to prevent cracking caused by the friction martensite as a result of chain speeds of > 0,5 m/s. This makes TSD Chains ideally suited for use on stage loaders (BSL).

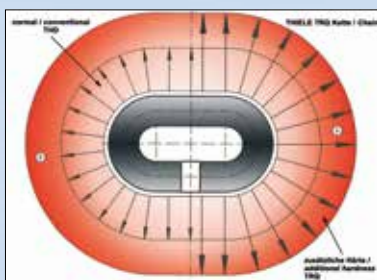

TRQ (THIELE Rock Quality)

(Strength: 424 - 453 HB10)

THIELE Rock Quality Chains (TRQ) were specially developed for the conveying of abrasive materials in stone drifts and roadway drivages. Careful tempering ensures hardness levels of 424 - 453 HB over the entire cross-section of the material and a uniform surface hardness at any point on the chain link.

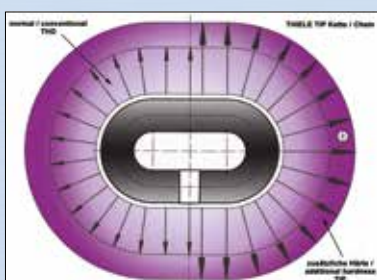

TIP (THIELE Improved Performance)

(Strength: 360 - 390 HB10)

THIELE TIP Chains have been developed for use on high-performance coal faces. By employing special alloyed steel the main operating parameters of these mining chains have been significantly improved without any loss in impact strength and deformability.

Breaking-strength comparison for THIELE chain grades

In the elastic range (up to the testing force) all chains exhibit the same characteristic because their elastic elongation is determined by their geometry alone. Plastic (permanent) deformation only sets in when the load applied begins to exceed the testing force. Because of the higher hardness levels of TSC and TSD Chains, correspondingly higher forces are needed to produce plastic deformation here.

Whatever the steel, increasing hardness naturally goes hand in hand with a reduction in the ultimate elongation or deformability of the material. This means that TSC and TSD Chains exhibit lower levels of elongation at break.

By using a special grade (TIP) of mining chain steel THIELE is able to increase the breaking force, hardness and wear resistance by approx. 5% while retaining the chain's impact strength and deformability. For TIP Chains the testing forces and breaking forces are therefore some 5% higher with no loss in ultimate elongation.

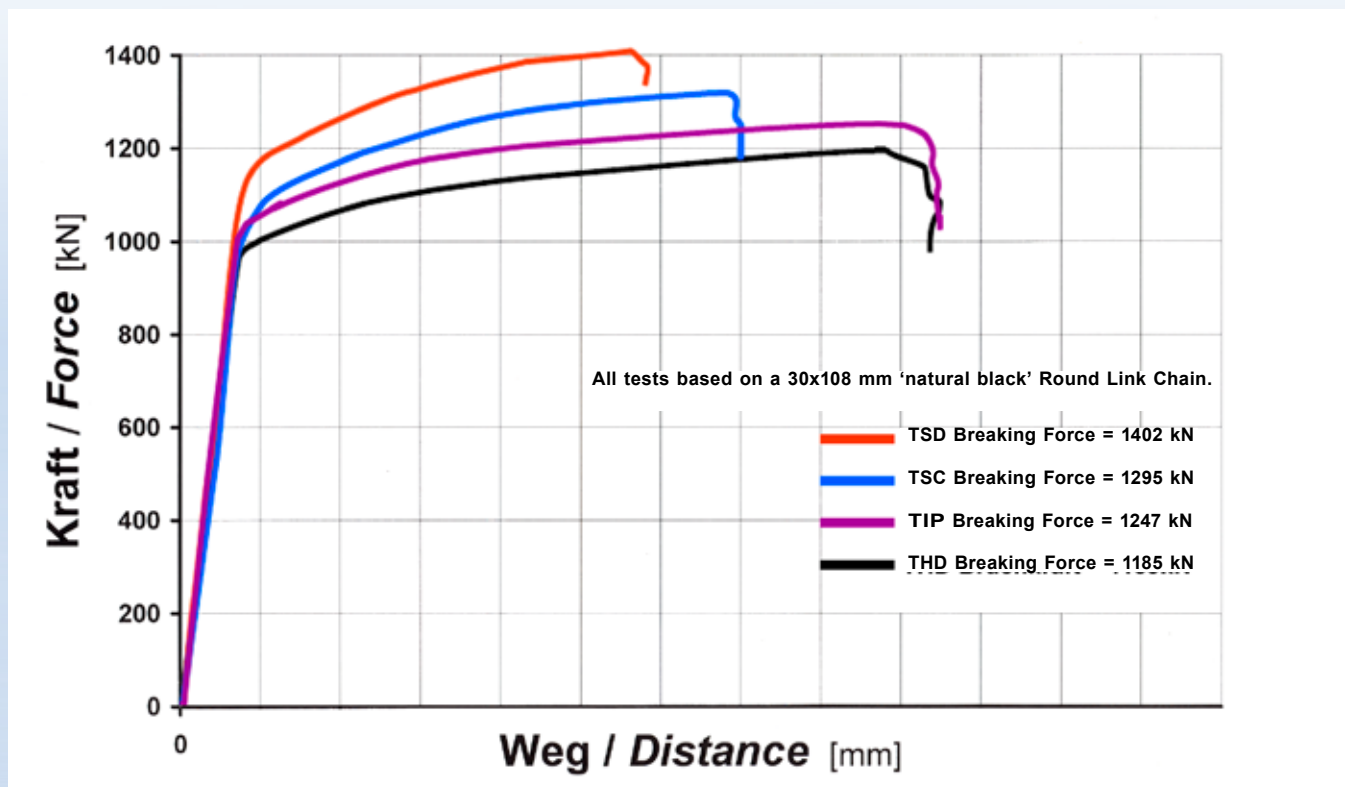



THIELE corrosion protection

1. Tectyl (TEC)

After heat treatment the chain surface can be described as 'natural black' (NSW). As corrosion products can form on this surface after just a few days in storage all THIELE chains – unless corrosion protected in some other way – are coated with Tectyl (TEC) for transport purposes. Tectyl is also a proven means for preventing corrosion during storage.

The duration of the corrosion protection afforded by Tectyl will depend on the weather and climatic conditions. Experience shows that chains whose Tectyl coatings remain intact are still fully fit for service after several months of storage outdoors.

Tectyl also acts as a running-in lubricant in that it eases the bedding-in process (progressive initial wear) that the chain links have to go through.



2. Hot-dip galvanising (TZN)

A considerable number of mines face very corrosive conditions. This is why THIELE has developed hot-dip galvanising (TZN) technology for chains intended for operating conditions of this type.

During the hot-dip galvanising process a permanent corrosion-proof coating is formed on the surface of the chain. This coating comprises two layers: an iron-zinc intermetallic phase and a solid zinc surface coating. This protective layer is smooth, non porous, highly adherent and therefore abrasion resistant. Even those surfaces that are exposed during underground service are still protected from corrosive attack. The phenomenon on which this observation is based is known as electrochemical or cathodic galvanising protection.

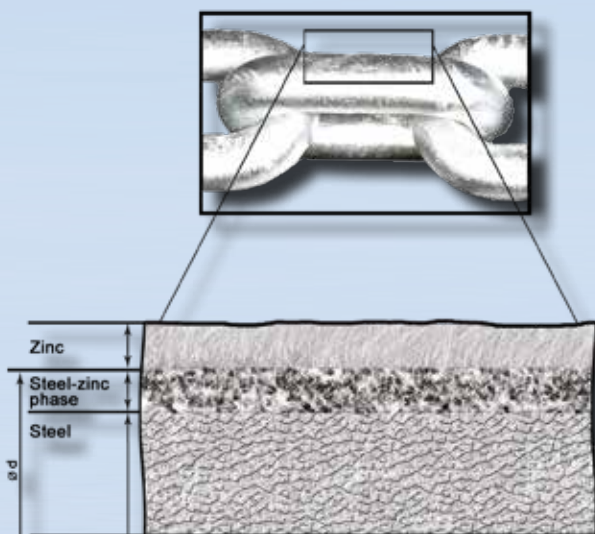

Long-term observations show that hot-dip galvanized chains have a greatly improved service life and chain failures are reduced significantly.

Hot-dip galvanising is the only effective and proven form of corrosion protection for mining chains.

THIELE corrosion protection

THIELE offers the following corrosion protection options to meet different underground conditions and storage times:

- a) Tectyl dipping (TEC) – for short storage times and favourable conditions (page 12)
- b) Hot-dip galvanising (TZN) – for longer storage periods or corrosive operating conditions (page 12)

For technical reasons (see DIN 22252) final testing is carried out before the corrosion protection is applied. The breaking force and ultimate elongation values therefore apply to the chain in its 'natural black' condition. Hot-dip galvanised chains are an exception in that they are again tested after galvanising.

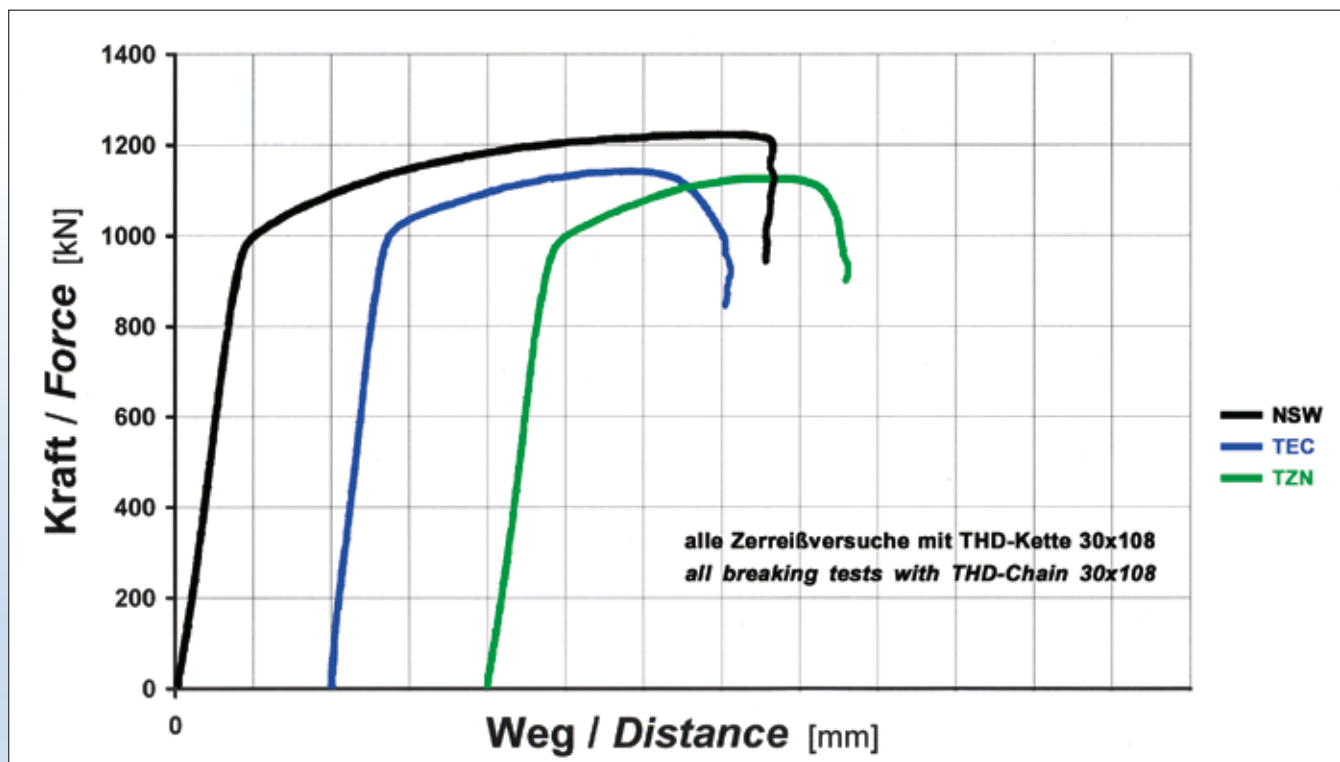

The chain breaking forces given in the relevant standards and catalogues refer to tensile tests on a 'natural black' chain surface of the type produced after heat treatment. This surface is covered with scale and typically exhibits a high degree of roughness and a high frictional resistance.

Each corrosion layer, whether Tectyl or zinc, reduces the breaking force of the THD chains by up to 10% and the ultimate elongation by as much as 20% when compared with the catalogue values (see also DIN 22252 and DIN 22255). The first contact with the conveyed product also produces the same result.

The application of an anti-corrosion layer does not however affect the quality or functionality of mining grade chains. It merely reduces the frictional resistance at the chain-link pivot points and the resulting breaking force and ultimate elongation values. The relevant chain-quality values, namely testing force, test elongation and operating force, along with the material strength, remain unchanged.



THIELE Round Link Chains

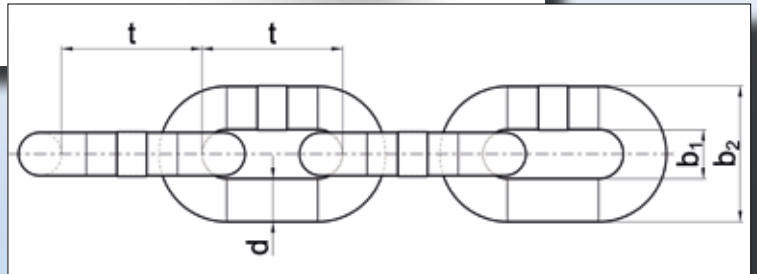
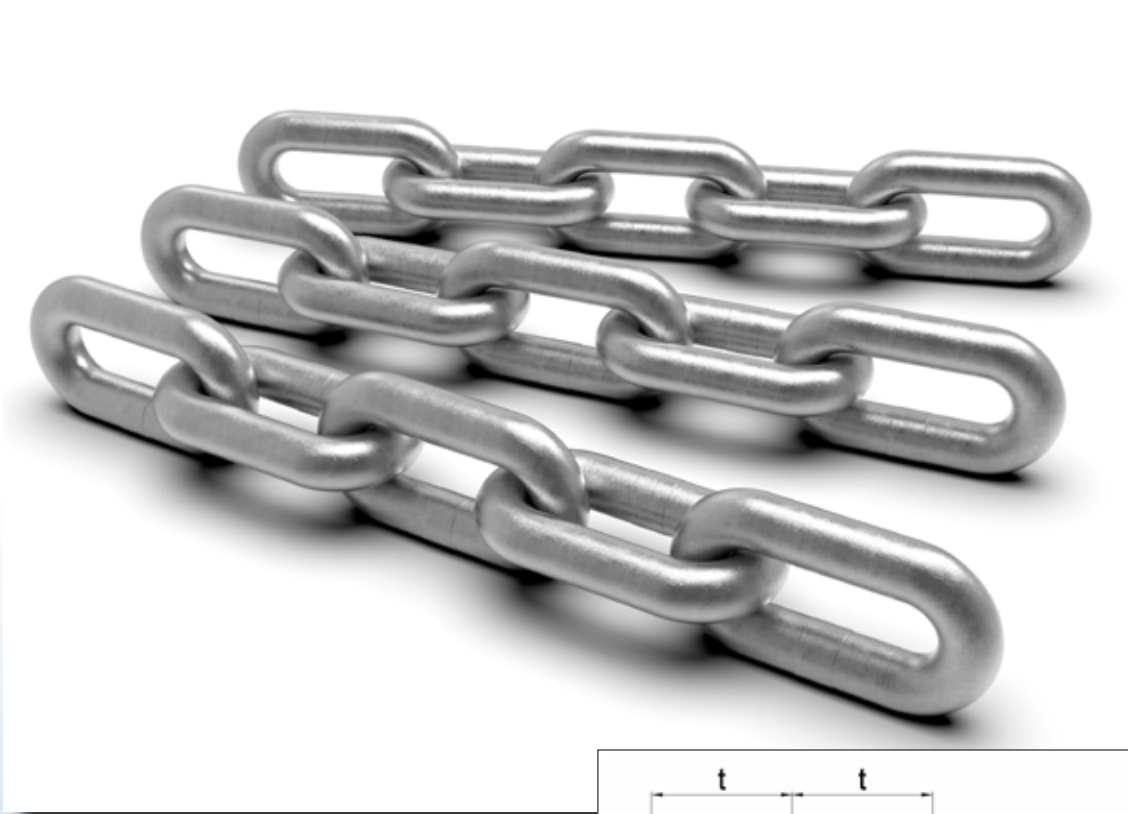

Weights and Dimensions (THD; TSC; TSD; TRQ; TIP; TZN)

Chain Size d x t [mm]	Diameter d	Pitch t	Inside Width b ₁ min.	Outside Width b ₂ max.	Length at n 5 x t	Weight [kg/m]
14 x 50	14 ± 0,4	50 ± 0,5	17	48	250 ± 1,0	4,0
18 x 64	18 ± 0,5	64 ± 0,6	21	60	320 ± 1,0	6,6
19 x 64,5	19 ± 0,6	64,5 ± 0,6	22	63	322,5 ± 1,0	7,6
22 x 86	22 ± 0,7	86 ± 0,9	26	73	430 ± 1,0	9,5
24 x 86	24 ± 0,7	86 ± 0,9	28	79	430 ± 1,0	11,6
26 x 92	26 ± 0,8	92 ± 0,9	30	85	460 ± 1,0	13,7
30 x 108	30 ± 0,9	108 ± 1,1	34	97	540 ± 1,1	18,0
34 x 126	34 ± 1,0	126 ± 1,3	38	109	630 ± 1,3	22,7
38 x 137	38 ± 1,1	137 ± 1,4	42	121	685 ± 1,4	29,0
42 x 137	42 ± 1,1	137 ± 1,4	48	139	685 ± 1,4	36,7

THIELE Heavy Duty (THD) Round Link Chains

DIN 22252

THIELE round-link chains can be used on both face conveyors and stage loaders and are also suitable as traction elements for coal ploughs. To ensure that its products can meet the tough demands of today's mining industry THIELE has developed its own chain steels based on many years of manufacturing know-how.

Each production stage is accompanied by careful and thorough quality control tests. THIELE chains are recognised the world over for their performance and durability.

This is why THD round-link steel chains are hardened and tempered to a strength of 345 – 375 HB10 (which applies uniformly over the entire link). For chains intended for face conveyors this strength level represents the optimum in terms of impact resistance (notch impact strength) and wear resistance (hardness).

Important for converting hardness measurements into tensile strength:

The strength specification of all THIELE chains is based on hardness measurements according to the Brinell scale.

Converting hardness measurements into tensile strength [MPa] has until now been carried out using Table A1 in DIN EN ISO 18265. The new DIN 22252 / 22255 however has changed over to Table B2. The quality grade and hardness specification for THIELE chains remains unchanged. Applying Table B2 produces a different set of tensile strengths from those of Table A1.

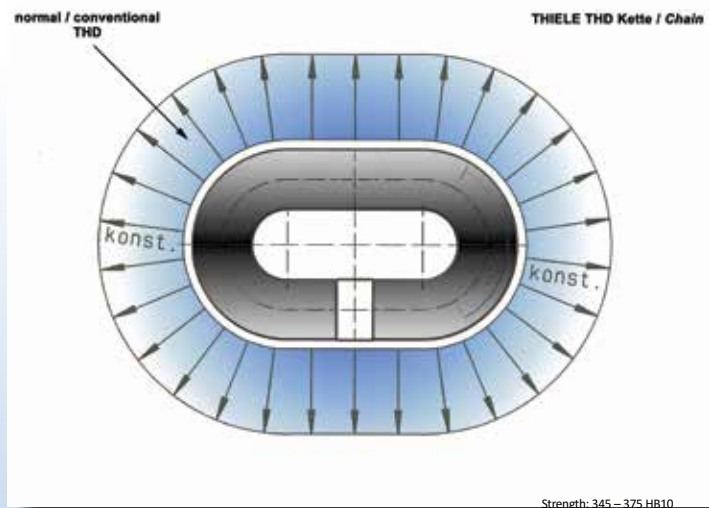

Mechanical Properties (THD; TZN)

Chain Size d x t [mm]	Article No. TEC	Article No. TZN	Test Force kN	Elongation under test force % max.	Breaking Force kN min.	Elongation at fracture %	Minimum Deflection [mm]
14 x 50	F13101	F13195	185	1,6	246	14	14
18 x 64	F13206	F13212	305	1,6	407	14	18
19 x 64,5	F13311	F13350	340	1,6	454	14	19
22 x 86	F13401	F13402	456	1,6	608	14	22
24 x 86	F13482	F13483	543	1,6	724	14	24
26 x 92	F13513	F13499	637	1,6	850	14	26
30 x 108	F13653	F13657	848	1,6	1.130	14	30
34 x 126	F13813	F13820	1.090	1,6	1.450	14	34
38 x 137	F13877	F138972	1.360	1,6	1.820	14	38
42 x 137	F15093	F15096	1.660	1,6	2.220	14	42

the above values apply to chains in 'natural black' condition (NSW)

THIELE Super Crown (TSC)

TWN 0100

THIELE developed the TSC series of Round Link Chains with wear-resistant crowns (THIELE Super Crown) in order to reduce link wear on plough chains and increase chain operating life.

As frictional heat in the fast running plough chains (which travel at over 3,0 m/s) leads to hardening of the legs and to dangerous crack formation the material strength of the legs is deliberately reduced by secondary heat treatment – thereby increasing the crack arrest capacity.

THIELE TSC chains are also used on scraper conveyors because of the increased hardness of their crowns. This extra hardness rating inevitably means that the chains are more susceptible to stress corrosion cracking and so TSC Chains are not recommended for corrosive environments – especially when fitted to face conveyors.

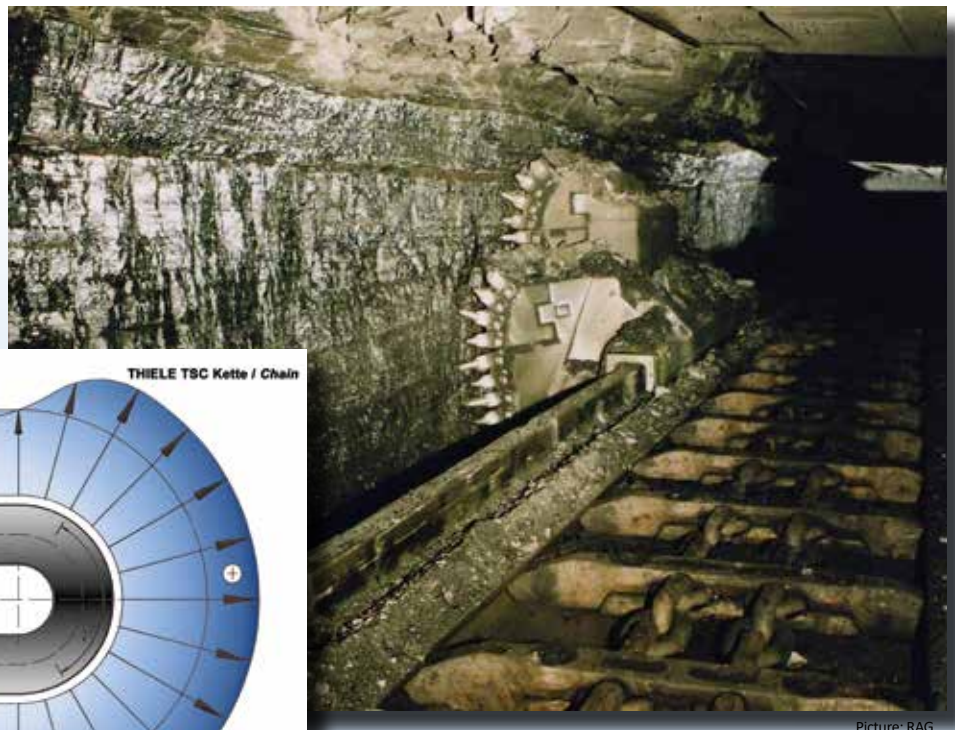

Picture: RAG

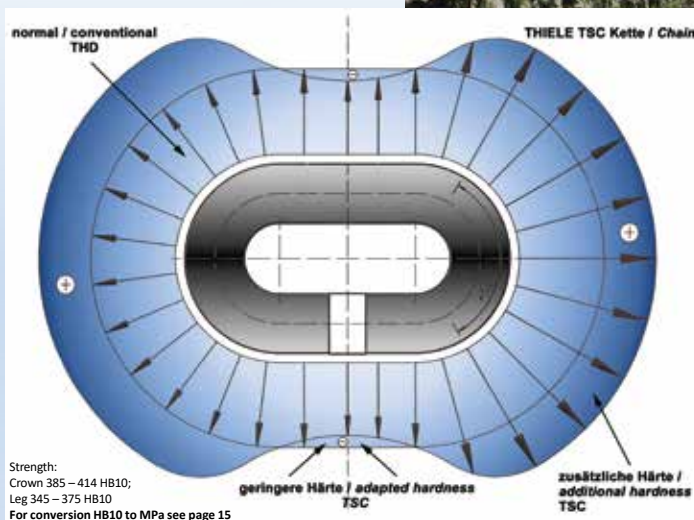

Chain Size d x t [mm]	Article No. TEC	Test Force kN	Elongation under test force % max.	Breaking Force kN min.	Elongation at fracture %	Minimum Deflection [mm]
22 x 86	F13394	456	1,4	670	18	22
26 x 92	F13506	637	1,4	940	18	26
30 x 108	F13646	848	1,4	1.250	18	30
34 x 126	F13872	1.090	1,4	1.610	18	34
38 x 137	F15090	1.360	1,4	2.010	18	38

the above values apply to chains in 'natural black' condition (NSW)

THIELE Super Duty (TSD)

TWN 0024

Like TRQ Chains, THIELE TSD Round Link Chains (THIELE Super Duty) were developed in order to achieve the greatest possible wear resistance when used on chain scraper conveyors and a higher breaking force. The material strength of the legs is deliberately reduced by precise heat treatment, which increases the crack arrest capacity in order to prevent cracking caused by the friction martensite as a result of chain speeds of > 0,5 m/s. This makes TSD Chains ideally suited for use on stage loaders (BSL).

The extreme crown hardness of TSD Chains results in a very high wear resistance and a higher breaking force too. The latter is however an unintentional side effect. As the increased hardness also means a reduction in toughness and a greater sensitivity to stress corrosion cracking TSD Chains are not recommended for use on face conveyors operating in a corrosive environment.

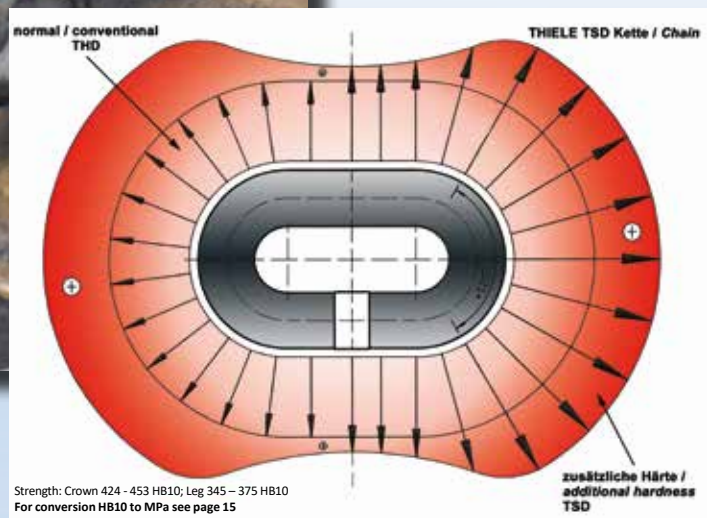
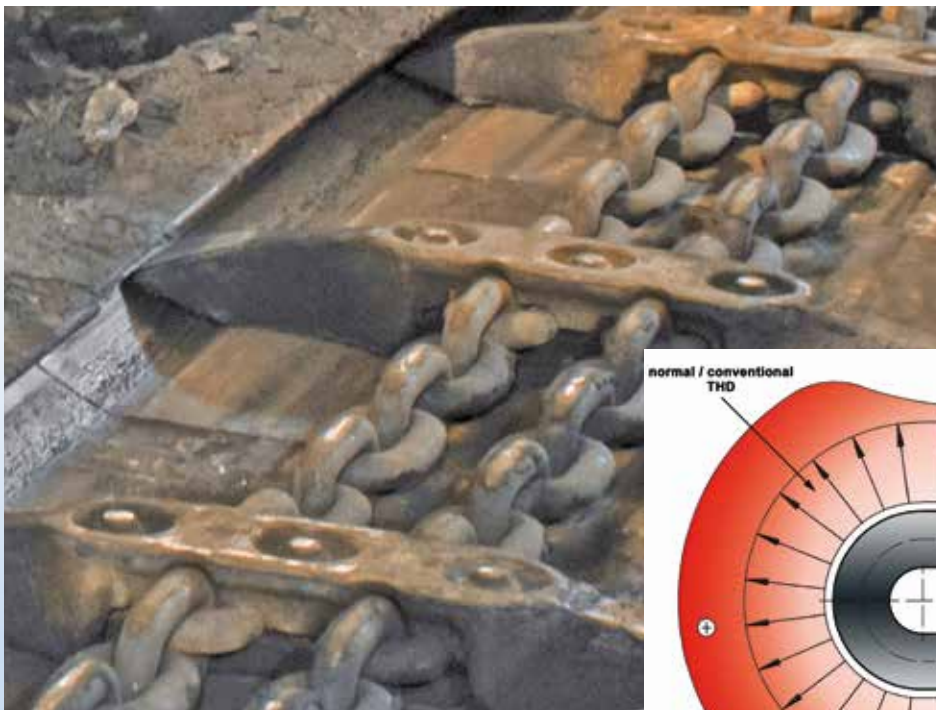

Chain Size d x t [mm]	Article No. TEC	Test Force kN	Elongation under test force % max.	Breaking Force kN min.	Elongation at fracture %	Minimum Deflection [mm]
22 x 86	F14009	530	1,6	750	16	18
24 x 86	F13454	630	1,6	900	16	19
26 x 92	F14005	740	1,6	1.050	16	21
30 x 108	F14045	990	1,6	1.400	16	24
34 x 126	F14077	1.270	1,6	1.800	16	27
38 x 137	F14085	1.590	1,6	2.250	16	30

the above values apply to chains in 'natural black' condition (NSW)

THIELE Rock Quality (TRQ)

TWN 0108

THIELE Rock Quality Chains (TRQ) were specially developed for the conveying of abrasive materials in stone drifts and roadway drivages. Careful tempering ensures hardness levels of 424 - 453 HB over the entire cross-section of the material and a uniform surface hardness at any point on the chain link.

The TRQ Chain also exhibits a high tensile strength with a fracture stress of 1000 N/mm². The combination of tensile strength and hardness opens up opportunities for use in difficult conveying situations where high tensile loads would rule out the use of surface hardened chains.

TRQ Chains can be operated up to a maximum speed of 0,5 m/s, as the frictional heat generated at higher chain speeds would result in hardening of the shanks and lead to dangerous crack formation.

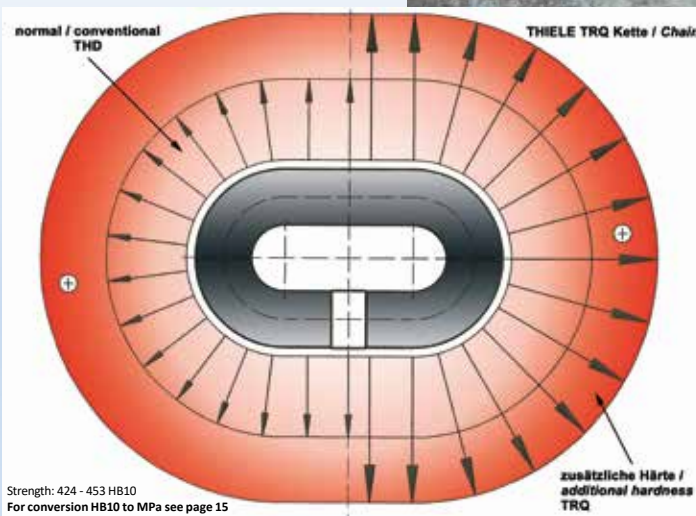

Chain Size d x t [mm]	Article No.	Test Force kN	Elongation under test force % max.	Breaking Force kN min.	Elongation at fracture %	Minimum Deflection [mm]
18 x 64	F13209	320	1,6	510	12	18
19 x 64,5	F13314	360	1,6	570	12	19
22 x 86	F13405	480	1,6	760	12	22
26 x 92	F13518	670	1,6	1.060	12	26
30 x 108	F13660	890	1,6	1.410	12	30
34 x 126	F13805	1.140	1,6	1.820	12	34
38 x 137	F15091	1.430	1,6	2.270	12	38

the above values apply to chains in 'natural black' condition (NSW)

THIELE Improved Performance (TIP)

THIELE TIP Round Link Chains have been developed for use on high-performance coal faces. By employing special alloyed steel the main operating parameters of these mining chains have been significantly improved without any loss in impact strength and deformability.

As the use of additional alloy constituents means higher material costs the added benefits of TIP Chains only begin to be felt on high-performance faces where the extra expenditure is soon offset by the higher face output and the higher working capabilities of the chains.

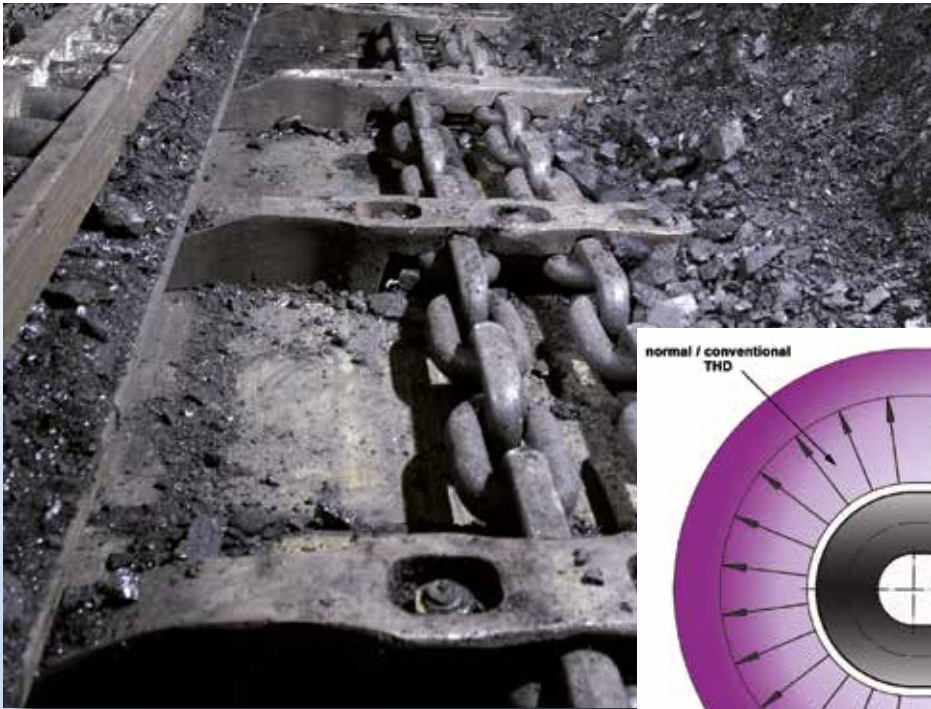

Picture: DBT

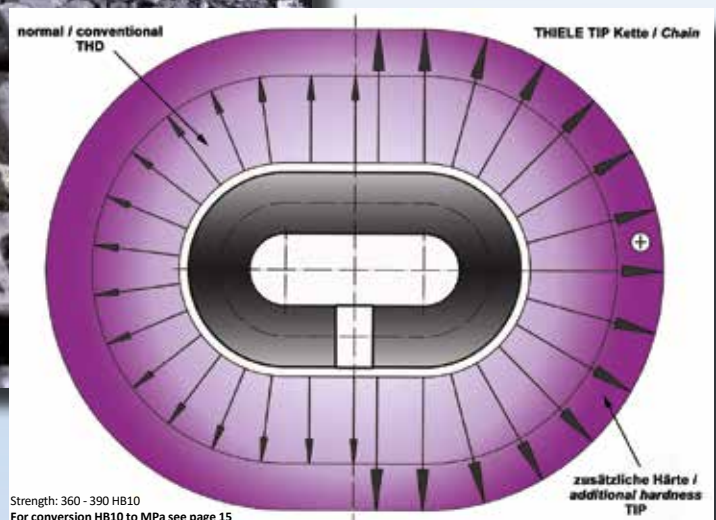

Chain Size d x t [mm]	Article No. TEC	Article No. TZN	Test Force kN	Elongation under test force % max.	Breaking Force kN min.	Elongation at fracture %	Minimum Deflection [mm]
30 x 108	F13658	on request	890	1,6	1.190	16	30
34 x 126	F13823	F13824	1.145	1,6	1.525	16	34

the above values apply to chains in 'natural black' condition (NSW)



THIELE Flat Type and DUALINK®-Chains

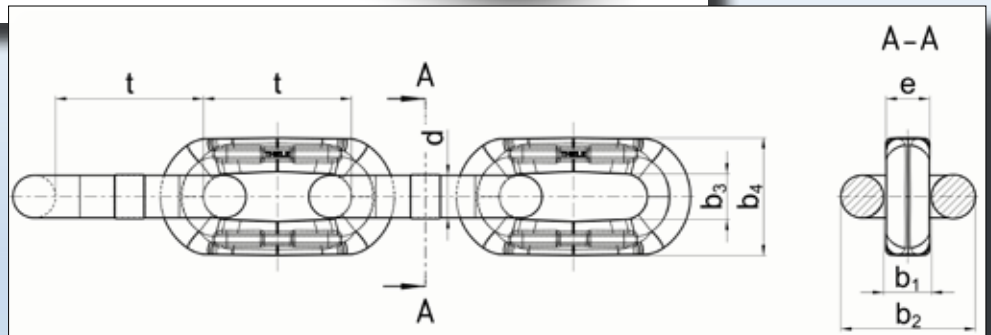

THIELE introduced another innovative product to the mining industry by inventing the flat-type chain in 1985. A flat-type chain is a round-link steel chain in which every second link – the vertical link – has flattened legs so that the overall height of the chain can be reduced.

This means that a chain conveyor can be upgraded to the next chain size with matching standard sprocket. THIELE Flat Type links can be produced by either welding and pressing or by forging (see DUALINK® chains).

Several years ago THIELE took things a stage further by developing its range of Super Flat Chains REINFORCED that again allow a chain conveyor to be upgraded from a Flat Type Chain to the next Super Flat Chain size, while retaining the standard sprocket (see page 26).

Some dimensions of THIELE's range of Flat Type and DUALINK® chains differ to DIN 22255, but represent long year practice / experience.



THIELE Flat Type and DUALINK®-Chains

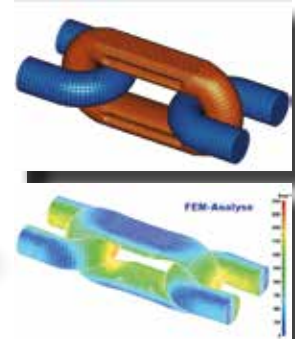

Weights and Dimensions (THD; TSC; TSD; TRQ; TIP; TZN) for Flat Type and DUALINK®-Chains

Chain Size d x t [mm]	Diameter d	Pitch t	Thick- ness e max.	Inside Width Round Link b ₁ min.	Outside Width Round Link b ₂ max.	Inside Width Flat Link b ₃ min.	Outside Width Flat Link b ₄ max.	Weight [kg/m]
24 x 86**	24 ± 0,7	86 ± 0,9	29	31	81	28	64	11,5
26 x 92**	26 ± 0,8	92 ± 0,9	30	31	85	29	75	13,7
30 x 108**	30 ± 0,9	108 ± 1,1	34	34,5	98	33	87	18,0
34 x 126	34 ± 1,0	126 ± 1,3	38	39	111	37	98	23,4
38 x 126*	38 ± 1,1	126 ± 1,3	42	42,1	123	42	111	30,1
38 x 137	38 ± 1,1	137 ± 1,4	42	42,1	123	42	111	29,0
38 x 146*	38 ± 1,1	146 ± 1,5	42	42,1	123	42	111	27,6
42 x 146	42 ± 1,1	146 ± 1,5	45,5	48	135	46	115	36,0
48 x 144/160*	48 ± 1,5	304***	56	62	163	57	127	48,2
48 x 152	48 ± 1,5	152 ± 1,5	54	61	162	52	126	46,5

* only as Flat Type Chain; ** only as DUALINK® Chain; *** module over two links



THD Flat Type Chains

TWN 0102

Chain Size d x t [mm]	Article No. TEC	Article No. TZN	Test Force kN	Elongation under test force % max.	Breaking Force kN min.	Elongation at fracture %	Minimum Deflection [mm]
34 x 126	F13807	F13808	1.090	1,6	1.450	11	34
38 x 126	F15051	F15052	1.360	1,6	1.820	11	38
38 x 137	F13891	F13893	1.360	1,6	1.820	11	38
38 x 146	F15076	on request	1.360	1,6	1.820	11	38
42 x 146	F15041	F15040	1.660	1,6	2.220	11	42
48 x 144/160	F14953	F14951	1.850	1,6	2.900	11	48
48 x 152	F14964	F14957	2.170	1,6	2.900	11	48

the above values apply to chains in 'natural black' condition (NSW)

THD DUALINK®-Chains

Chain Size d x t [mm]	Article No. TEC	Article No. TZN	Test Force kN	Elongation under test force % max.	Breaking Force kN min.	Elongation at fracture %	Minimum Deflection [mm]
24 x 86	F13485	on request	543	1,6	724	11	24
26 x 92	F14933	on request	637	1,6	850	11	26
30 x 108	F13666	on request	848	1,6	1.130	11	30
34 x 126	F13842	on request	1.090	1,6	1.450	11	34
38 x 137	F13918	F13917	1.360	1,6	1.820	11	38
42 x 146	F15021	F15015	1.660	1,6	2.220	11	42
48 x 152	F14956	F14954	2.170	1,6	2.900	11	48

the above values apply to chains in 'natural black' condition (NSW)

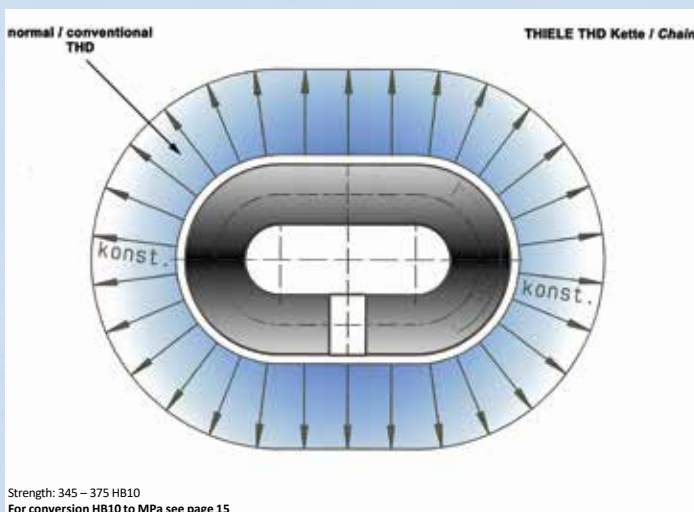

Most of the world's face conveyors now use Flat Type / DUALINK® Chains from the THD range.

THIELE offers the following types of corrosion protection for THD Flat Type / DUALINK® Chains, depending on underground conditions and storage times:

- Tectyl dipped (TEC) – for short storage times and good conditions (page 12)
- Hot-dip galvanised (TZN) – for longer storage times and corrosive operating conditions (page 12)



TSC Flat Type Chains

TWN 0026

Chain Size d x t [mm]	Article No.	Test Force kN	Elongation under test force % max.	Breaking Force kN min.	Elongation at fracture %	Minimum Deflection [mm]
34 x 126	F13801	1.090	1,4	1.610	11	34
38 x 126	F15054	1.360	1,4	2.010	11	38
38 x 137	F13912	1.360	1,4	2.010	11	38
38 x 146	F15086	1.360	1,4	2.010	11	38
42 x 146	F15023	1.660	1,4	2.450	11	42
48 x 152	F14959	2.170	1,4	3.250	11	48

the above values apply to chains in 'natural black' condition (NSW)

TSC DUALINK®-Chains

Chain Size d x t [mm]	Article No.	Test Force kN	Elongation under test force % max.	Breaking Force kN min.	Elongation at fracture %	Minimum Deflection [mm]
30 x 108	F13774	848	1,4	1.250	11	30
38 x 137	F13919	1.360	1,4	2.010	11	38
42 x 146	F13909	1.660	1,4	2.450	11	42
48 x 152	F14963	2.170	1,4	3.250	11	48

the above values apply to chains in 'natural black' condition (NSW)

TSC Flat Type / DUALINK® Chains provide high wear resistant crowns (THIELE Super Crown) and are recommended for BSL-applications.

TSC Chains are not recommended for corrosive environments – especially in face-conveyor applications – due to the risk of stress corrosion cracking.

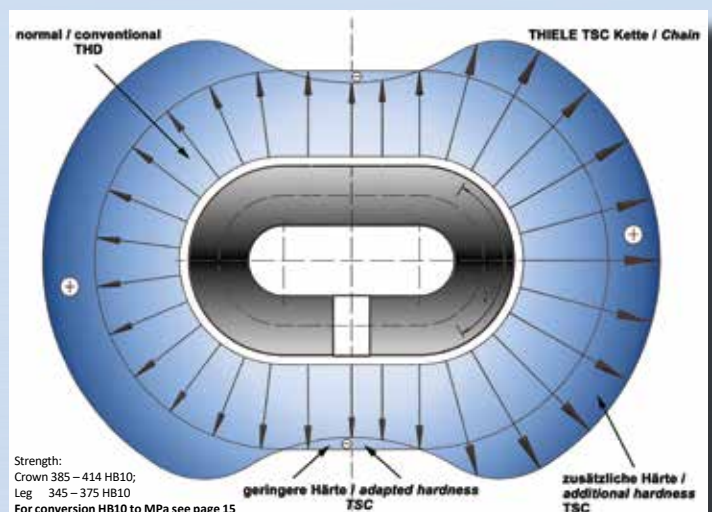



TSD Flat Type Chains

TWN 0025

Chain Size d x t [mm]	Article No.	Test Force kN	Elongation under test force % max.	Breaking Force kN min.	Elongation at fracture %	Minimum Deflection [mm]
34 x 126	F13799	1.270	1,6	1.800	11	27
38 x 126	F15066	1.590	1,6	2.250	11	30
38 x 137	F13996	1.590	1,6	2.250	11	30
38 x 146	F15085	1.590	1,6	2.250	11	30
42 x 146	F15049	1.940	1,6	2.740	11	34

the above values apply to chains in 'natural black' condition (NSW)

TSD DUALINK®-Chains

Chain Size d x t [mm]	Article No.	Test Force kN	Elongation under test force % max.	Breaking Force kN min.	Elongation at fracture %	Minimum Deflection [mm]
30 x 108	F13777	990	1,6	1.400	11	24
38 x 137	F13914	1.590	1,6	2.250	11	30
42 x 146	F13907	1.940	1,6	2.740	11	34

the above values apply to chains in 'natural black' condition (NSW)

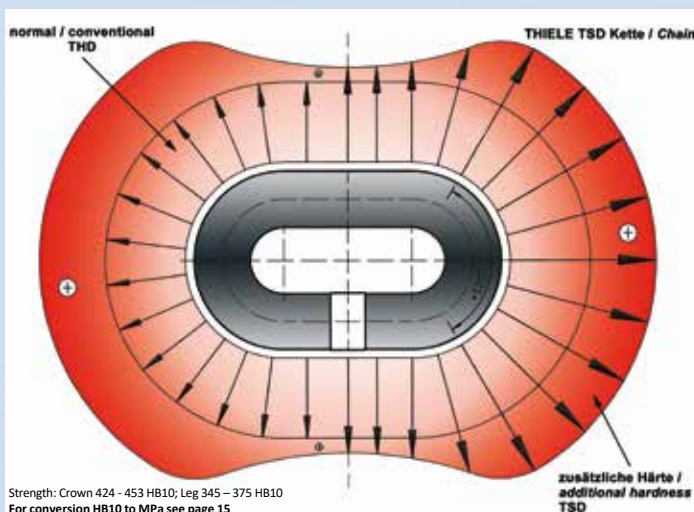

TSD Flat Type / DUALINK® Chains provide very high wear resistant crowns (THIELE Super Duty) and are widely used / recommended in BSL-applications.

TSD Chains are not recommended for wet or aggressive operating conditions as their high strength specifications make them susceptible to stress corrosion cracking.



TIP Flat Type Chains

Chain Size d x t [mm]	Article No.	Test Force kN	Elongation under test force % max.	Breaking Force kN min.	Elongation at fracture %	Minimum Deflection [mm]
38 x 126	F15051TIP	1.430	1,6	1.910	11	38
38 x 137	F13891TIP	1.430	1,6	1.910	11	38
38 x 146	F15076TIP	1.430	1,6	1.910	11	38
42 x 146	F15046	1.750	1,6	2.330	11	42
48 x 152	F14964TIP	2.280	1,6	3.040	11	48

the above values apply to chains in 'natural black' condition (NSW)

TIP DUALINK®-Chains

Chain Size d x t [mm]	Article No.	Test Force kN	Elongation under test force % max.	Breaking Force kN min.	Elongation at fracture %	Minimum Deflection [mm]
38 x 137	F13918TIP	1.430	1,6	1.910	11	38
42 x 146	F15020	1.750	1,6	2.330	11	42
48 x 152	F14967	2.280	1,6	3.040	11	48

the above values apply to chains in 'natural black' condition (NSW)

THIELE TIP Chains have been developed for use on high-performance coal faces. By employing special alloyed steel the main operating parameters of these mining chains have been significantly improved without any loss in impact strength and deformability.

As the use of additional alloy constituents means higher material costs the added benefits of TIP Chains only begin to be felt on high-performance faces where the extra expenditure is soon offset by the higher face output and the higher working capabilities of the chains.

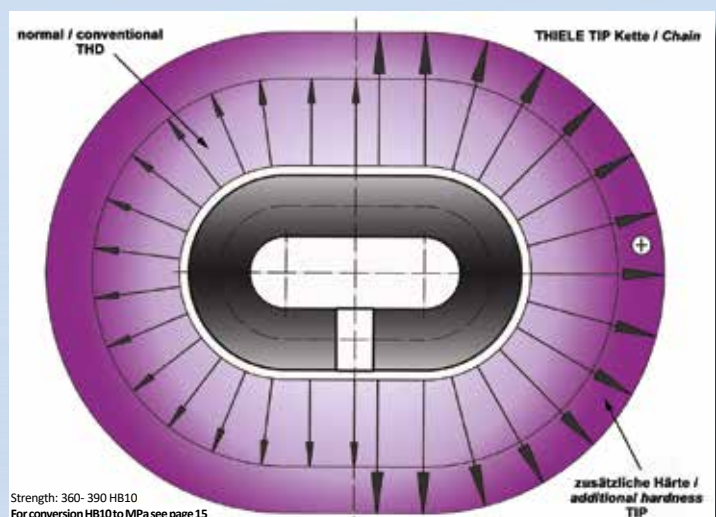

THIELE Super Flat Type Chains REINFORCED



THIELE Super Flat Type Chains REINFORCED are mining chains for chain scraper conveyors that are a nominal size flatter than the standard Flat Type Chains. The advantage of the Super Flat REINFORCED design is that it offers greater clearance in the pan profiles thus reducing wear grooves in the bottom plate. Super Flat Type Chains REINFORCED also allow the existing conveyor to be upgraded from a Flat Type Chain to the next Super Flat Type Chain REINFORCED size.

THIELE's patented 'REINFORCED' Super Flat Type Chain offers all the advantages of the THIELE Super Flat Type Chain, such as low design height, anti-kink stud and reduced tendency to develop chain slack.

In addition, the THIELE 'REINFORCED' Super Flat Type Chain features a significant strengthening of the wear zone in the crown, which gives the 'REINFORCED' version a much higher resistance to wear. This is of particular advantage when running chains of 42 mm and larger.

Additional advantages of Super Flat Type Chains REINFORCED:

- ⊕ the vertical links have a central full stud that prevents kinking and increases the chain breaking force
- ⊕ the central full stud and FEM-optimised shape of the vertical links increase the modulus of elasticity of the Super Flat Type Chains REINFORCED, which in turn helps reduce chain slack
- ⊕ available in different grades: THD, TSC, TSD, TIP and TZN
- ⊕ compatible with existing flight bars for Round Link or Flat Type Chains of the same nominal size



THIELE Super Flat Type Chains REINFORCED

strengthening of the wear zone in the crown THIELE Super Flat Type Chains REINFORCED

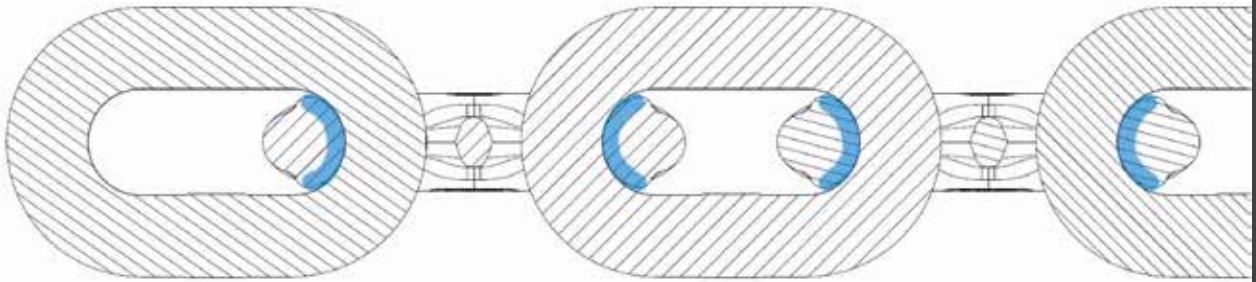

The service life of mining chains is often limited by the effect of wear on the chain links. When chain stretch exceeds 3 or 4% problems begin to arise at the interface between chain and sprocket. In order to extend the operating life of a chain it is necessary to reduce the rate of interlink wear and so slow down the chain elongation process. The solution patented by THIELE - which involves strengthening the forged vertical links on the super-flat chains - increases the contact surfaces of the chain links and creates a greater volume of material that has to be worn away by abrasion before chain elongation sets in.

Thanks to the 3D design process the crowns on the vertical links can be strengthened in such a way that all the design dimensions (which are critical for the compatibility of the chain with the scraper bars and sprockets) remain unchanged.

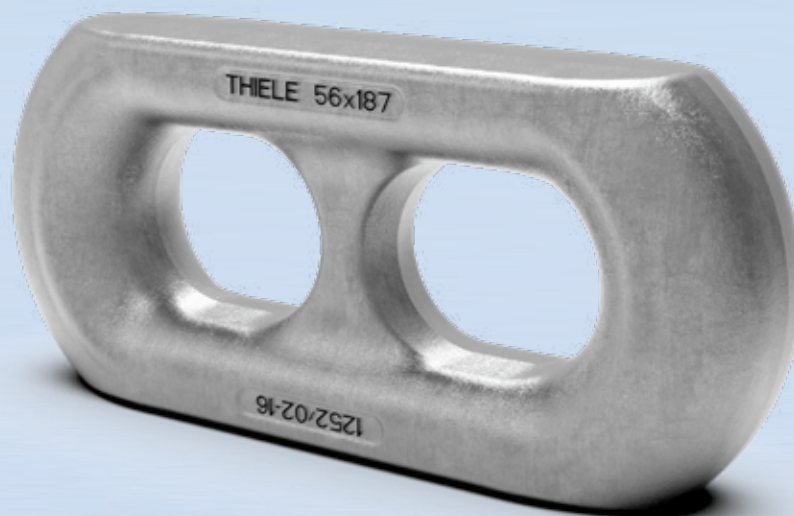



THIELE Super Flat Type Chains REINFORCED

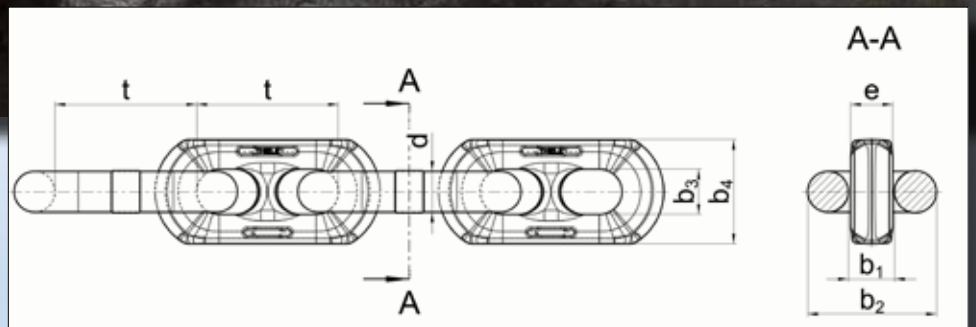

Weights and Dimensions (THD; TSC; TSD; TIP; TZN)

Chain Size d x t [mm]	Diameter d	Pitch t	Thick- ness e max.	Inside Width Round Link b ₁ min.	Outside Width Round Link b ₂ max.	Inside Width Flat Link b ₃ min.	Outside Width Flat Link b ₄ max.	Weight [kg/m]
30 x 108*	30 ± 0,9	108 ± 1,1	34,0	34	99	34,0	81,0	18,1
34 x 126	34 ± 1,0	126 ± 1,3	37,0	38	111	38,0	85,0	21,7
38 x 126	38 ± 1,1	126 ± 1,3	42,2	43	123	42,0	101,3	29,5
38 x 137	38 ± 1,1	137 ± 1,3	42,2	43	123	42,0	101,3	28,5
42 x 146	42 ± 1,1	146 ± 1,5	47,3	48	135	45,5	109,0	34,6
48 x 144/160	48 ± 1,5	304**	53,0	62	163	52,2	116,5	43,0
48 x 152	48 ± 1,5	152 ± 1,5	53,0	62	163	52,2	116,5	46,8
52 x 170	52 ± 1,6	170 ± 1,7	62,0	65	177	56,0	126,0	56,0
56/60 x 187	56 ± 1,5	187 ± 1,9	65,0	71	189	61,0	132,0	62,0
62x181 / 58x197	60 N/A	378**	70,0	73	198	63,0	136,0	68,2
64 x 190/230	64 ± 1,9	420**	76,0	80	220	69,0	153,5	79,0

* without REINFORCED feature (normal Super Flat Type Chain); ** Modul over 2 links

THIELE Super Flat Type Chains REINFORCED

Mechanical Properties (THD; TZN)

Chain Size d x t [mm]	Article No. TEC	Article No. TZN	Test Force kN	Elongation under test force % max.	Breaking Force kN min.	Elongation at fracture %	Minimum Deflection [mm]
30 x 108*	F15133*	on request	848	1,6	1.130	11	30
34 x 126	F15002	F15005	1.090	1,6	1.450	11	34
38 x 126	F15036	on request	1.360	1,6	1.820	11	38
38 x 137	F15142	on request	1.360	1,6	1.820	11	38
42 x 146	F15180	F15182	1.660	1,6	2.220	11	42
48 x 144/160	F15134	F15135	1.850	1,6	2.900	11	48
48 x 152	F15190	F15192	2.170	1,6	2.900	11	48
52 x 170	F15106	F15101	2.550	1,6	3.400	11	52
56/60 x 187	F15197	on request	3.000	1,6	3.940	11	56
62x181 / 58x197	F15103	F15104	3.390	1,6	4.520	11	58
64 x 190/230	F13903	on request	3.860	1,6	5.150	11	64

* without REINFORCED feature (normal Super Flat Type Chain)

the above values apply to chains in 'natural black' condition (NSW)

Mechanical Properties (TSC)

Chain Size d x t [mm]	Article No. TEC	Test Force kN	Elongation under test force % max.	Breaking Force kN min.	Elongation at fracture %	Minimum Deflection [mm]
34 x 126	F15004	1.090	1,4	1.450	11	34
38 x 126	F15035	1.360	1,4	1.820	11	38

the above values apply to chains in 'natural black' condition (NSW)

Mechanical Properties (TSD)

Chain Size d x t [mm]	Article No. TEC	Test Force kN	Elongation under test force % max.	Breaking Force kN min.	Elongation at fracture %	Minimum Deflection [mm]
34 x 126	F15003	1.090	1,6	1.450	11	27
38 x 126	F15031	1.360	1,6	1.820	11	30
42 x 146	F15181	1.660	1,6	2.220	11	34

the above values apply to chains in 'natural black' condition (NSW)

Mechanical Properties (TIP)

Chain Size d x t [mm]	Article No. TEC	Article No. TIP-TZN	Test Force kN	Elongation under test force % max.	Breaking Force kN min.	Elongation at fracture %	Minimum Deflection [mm]
34 x 126	F15007	F15006	1.145	1,6	1.530	11	34
42 x 146	F15180TIP	F15178	1.750	1,6	2.330	11	42
48 x 144/160	F15200TIP	F15202	2.280	1,6	3.040	11	48
48 x 152	F15188	F15194	2.280	1,6	3.040	11	48
52 x 170	F15106TIP	on request	2.680	1,6	3.570	11	52

the above values apply to chains in 'natural black' condition (NSW)



THIELE BIG-T® Chains

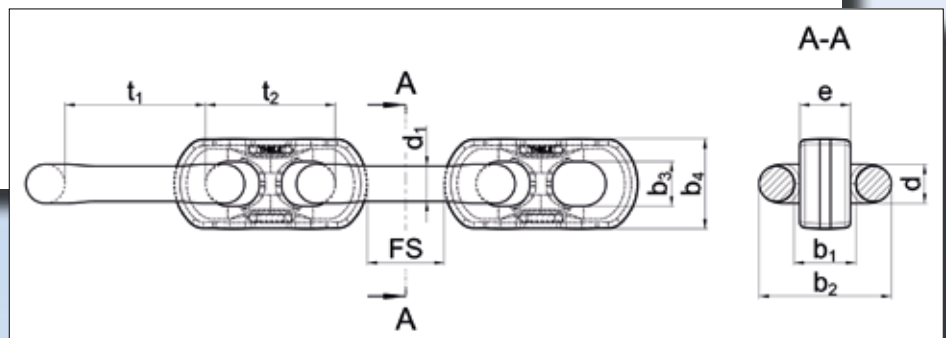
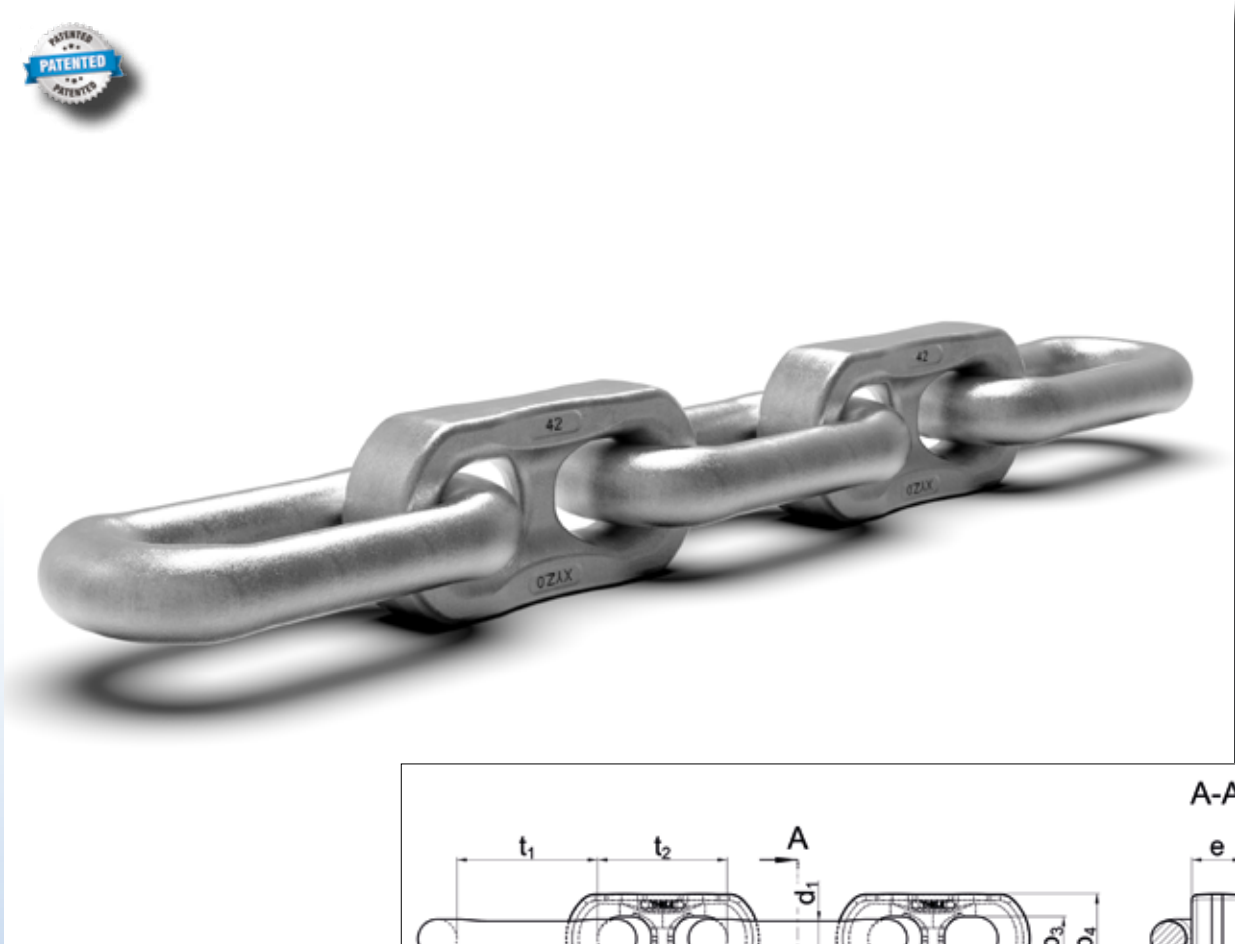

Weights and Dimensions

Chain Size d x t [mm]	Dia- meter d	Pitch t_1	Pitch t_2	Flight Bar Space FS	Thick- ness e max.	Leg ϕ Round Link d_1 max.	Inside Width Round Link b_1 min.	Outside Width Round Link b_2 max.	Inside Width Flat Link b_3 min.	Outside Width Flat Link b_4 max.	Weight [kg/m]
34 x 121/131	34 ± 0,9	121 ± 1,3	131 ± 1,3	76	47,1	30,7 ± 0,8	57	123	38,1	79,3	21,8
42 x 140/152	42 ± 1,1	140 ± 1,5	152 ± 1,5	83	56,1	37,8 ± 1,1	67	148	45,1	99,1	33,8
48 x 143/161	48 ± 1,5	143 ± 1,5	161 ± 1,6	82	62,4	44,3 ± 1,4	73	170	52,9	113,5	46,3
52 x 152/168	52 ± 1,6	152 ± 1,6	168 ± 1,6	82	66,1	48,0 ± 1,6	77	183	57,0	122,6	54,1
56 x 168/184	56 ± 1,7	168 ± 1,7	184 ± 1,8	94	75,2	52,0 ± 1,5	81	195	60,8	132,0	62,0
60 x 181/197	60 ± 1,9	181 ± 1,8	197 ± 2,0	100	82,5	55,5 ± 1,6	85	207	66,0	142,0	72,2

Technical specifications subject to change

THIELE BIG-T® Chains

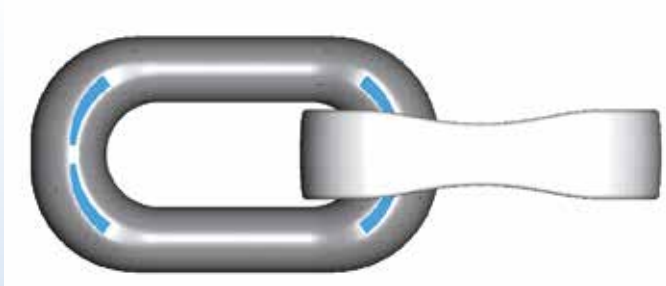
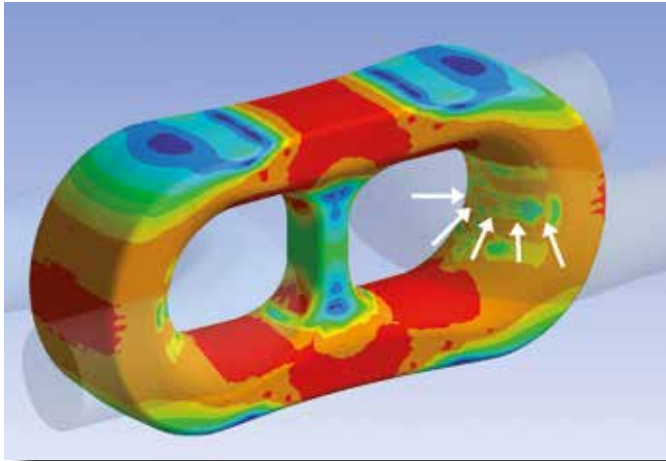

The newly developed multi-point contact principle of the BIG-T® chain allows the effective contact area to be increased by distributing the contact zone uniformly over the entire zone between the two outer endpoints. Contact pressure, and hence chain wear, is therefore significantly reduced.

The vertical link is also broader and flatter in design. This increase in width creates a much larger wearing surface and provides increased wear resistance, so that the overall wear behaviour of the chain is very much improved.

The flatter design of this chain – which is even flatter than the super flat chain – makes it suitable for use on extremely compact conveyors (for low-seam applications), or produces an extremely strong and durable chain for a given pan profile.

The leg diameter d_1 is much smaller than the nominal diameter d – without any loss in chain performance.

The benefits include up to 15% saving in weight at the round link and a larger volume of material at the critical flight-bar profile, which significantly increases the stiffness and breaking force of the flight bar. The smaller leg diameter d_1 allows to keep the outer width of the round link as small as possible, which is a general advantage for the flightbar design, when it comes to compact sizes, but high capacity requirements. The chain centre-to-centre spacing therefore remains unaltered, in spite of the larger nominal size.

Mechanical Properties (THD)

Chain Size d x t [mm]	Article No.	Test Force kN	Elongation under test force % max.	Breaking Force kN min.	Elongation at fracture %	Minimum Deflection [mm]
34 x 121/131	F15505	1.090	1,4	1.450	11	34
42 x 140/152	F15506	1.660	1,4	2.220	11	42
48 x 143/161	F15501	2.170	1,4	2.900	11	48
52 x 152/168	F15502	2.550	1,4	3.400	11	52
56 x 168/184	F15503	2.960	1,4	3.940	11	56
60 x 181/197	F15504	3.390	1,4	4.520	11	60

the above values apply to chains in 'natural black' condition (NSW) / Technical specifications subject to change

Mechanical Properties (TSD)

Chain Size d x t [mm]	Article No.	Test Force kN	Elongation under test force % max.	Breaking Force kN min.	Elongation at fracture %	Minimum Deflection [mm]
34 x 121/131	F15507	1.090	1,6	1.450	11	27
42 x 140/152	F15508	1.660	1,4	2.220	11	34

the above values apply to chains in 'natural black' condition (NSW) / Technical specifications subject to change



BROADBAND Low Profile Chain



“BROADBAND low profile chain” is a trademark of Joy Mining Machinery part of Joy Global Inc.

Mechanical Properties (THD, TZN)

Chain Size d x t [mm]	Art. No. TEC	Art. No. TZN	Test Force kN	Elongation under test force % max.	Breaking Force kN min.	Elongation at fracture %	Minimum Deflection [mm]
38 x 126/148	F13977	F13976	1.360	1,4	1.820	11	38
42 x 128/164	F14920	F14923	1.660	1,4	2.200	11	42
50 x 146/174	F13951	F13942	2.260	1,4	3.015	11	49
56 x 168/204	F13989	F13968	2.900	1,4	4.000	11	56
60 x 180/220	F13999	on req.	3.395	1,4	4.525	11	60
64 x 192/234	F13901	on req.	3.860	1,4	5.150	11	64

the above values apply to chains in 'natural black' condition (NSW)

For all face conveyors with normal and high production output demands, we recommend the THD grade chains. This THD grade was developed to provide the chain with the longest operating life under typical conditions of wear, corrosion, and fatigue.

Under very corrosive conditions, we recommend using the hot-dip galvanized TZN chains, which prevent any type of corrosion.



BROADBAND Low Profile Chain

Info:
The system uses THIELE BLOCKMASTER®-CP or SP-S connectors. These are shown on page 34.

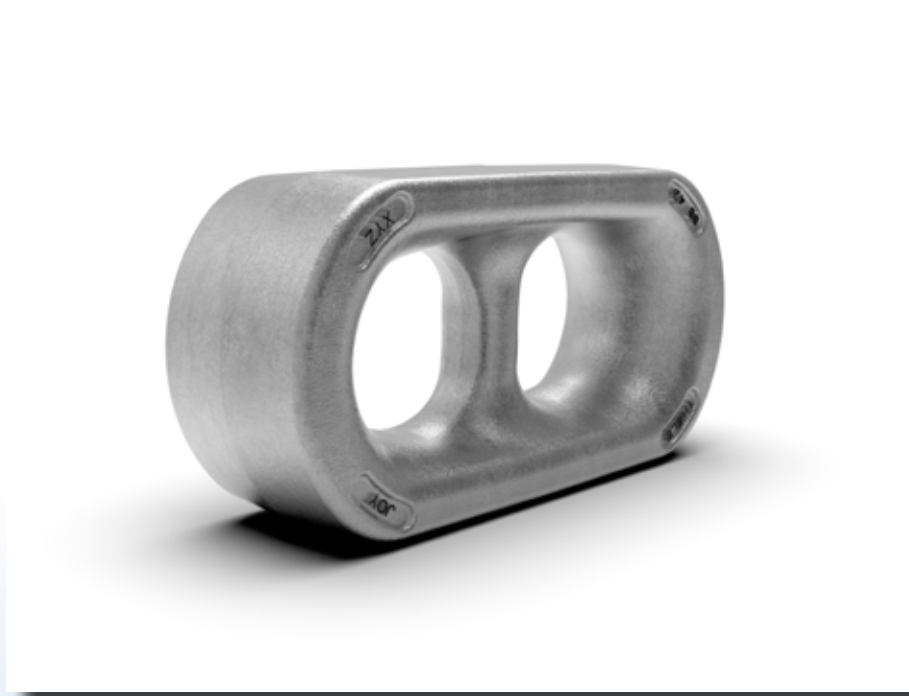

Mechanical Properties (TIP, TIP-TZN)

Chain Size d x t [mm]	Art. No. TEC	Art. No. TIP-TZN	Test Force kN	Elongation under test force % max.	Breaking Force kN min.	Elongation at fracture %	Minimum Deflection [mm]
38 x 126/148	F13975	F13979	1.420	1,4	1.895	11	38
42 x 128/164	F14924	F14925	1.740	1,4	2.320	11	42
50 x 146/174	F13927	F13926	2.360	1,4	3.140	11	49
56 x 168/204	F13967	F13969	3.050	1,4	4.060	11	56
60 x 180/220	F13955	on request	3.680	1,4	4.760	11	60
64 x 192/234	on request	on request	4.020	1,4	5.310	11	64

the above values apply to chains in 'natural black' condition (NSW)

For all face conveyors with very high production output demands, specifically drive capacity and very high chain operating forces, the TIP chain grade was developed, which allows for a slightly higher breaking force with the same toughness. For situations demanding high drive capacity, or chain strength, which also contain a corrosive environment, the TIP hot-dip galvanized chains can be used without having to sacrifice breaking strength or impact strength.

Mechanical Properties (TSC)

Chain Size d x t [mm]	Art. No. TEC	Test Force kN	Elongation under test force % max.	Breaking Force kN min.	Elongation at fracture %	Minimum Deflection [mm]
38x126/148	F13978	1.360	1,4	2.010	11	38
42x128/164	F13980	1.660	1,4	2.450	11	42

the above values apply to chains in 'natural black' condition (NSW)

For all types of stage loader conveyor requirements, the TSC chain grade was developed for optimal resistance against wear.

BLOCKMASTER® for BROADBAND Low Profile Chain

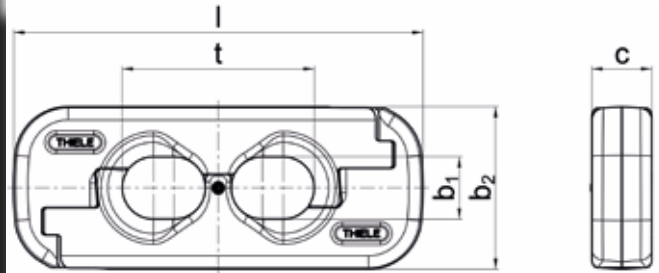

Chain Size d x t [mm]	Article No.	d	t	b ₁ min.	b ₂ max.	l max.	c max.	Breaking Force kN min.	Weight kg	Roll Pins Article No.
38 x 126/148	F26338*	38	126	40	86	315	54	2.050	8,4	Z03608 / Z00299
42 x 128/164	F26348*	42	128	44	99	343	60	2.500	12,0	Z03892 / Z00311
50 x 146/174	F26365*	50	146	52	116,8	367	64,1	3.390	16,0	Z03892 / Z00311
56 x 168/204	F26375**	56	168	61	130	405	74,1	4.000	22,8	Z10176 / Z10177
56 x 168/204	F26377*	56	168	61	130	403	75	4.000	21,5	Z10176 / Z10177

condition at time of delivery: blue coated RAL5002
* BLOCKMASTER-CP; ** BLOCKMASTER Ultra 3.1

the above values apply to connectors in 'natural black' condition (NSW)

SP-S Connector for BROADBAND Low Profile Chain

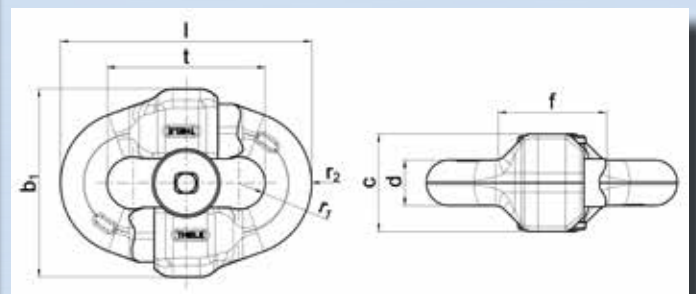

Chain Size d x t [mm]	Article No.	d	t	b ₁ max.	c max.	f max.	l max.	r ₂ +1	Work Force WF kN max.	Breaking Force kN min.	Weight kg
38 x 126/148	F26168	38	148	146	87	77	228	72	1.130	1.820	8,0
42 x 128/164	F26178	42	164	172	80	90	248	80	1.380	2.220	10,2

condition at time of delivery: galvanized

the above values apply to connectors in 'natural black' condition (NSW)















THIELE mining chain connectors



THIELE can supply a wide range of mining chain connectors. All our connectors are manufactured using state-of-the-art production methods and come with the THIELE 'long life' guarantee.

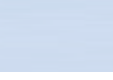

Product range – mining chain connectors:

- | | | | |
|---|--------------------------|------------|---|
|  | - Flat Type Connectors | page 36 |  |
|  | - TKF-Connectors | page 36 |  |
|  | - DMK-Connectors | page 37 |  |
|  | - SP Connectors | page 37 |  |
|  | - SP-S Connectors | page 38 |  |
|  | - Power Chain Connectors | page 39 |  |
| | - PLOWMASTER®-S | page 39 |  |
| | - BLOCKMASTER® | page 40-41 | |
| | - BLOCKCHAMPION® | page 42-43 | |

Flat Type Connectors

TWN 0142



The Flat Type Connector was specially developed for vertical and horizontal applications.

The mechanical properties are at least the equivalent of DIN 22258 Part 1.

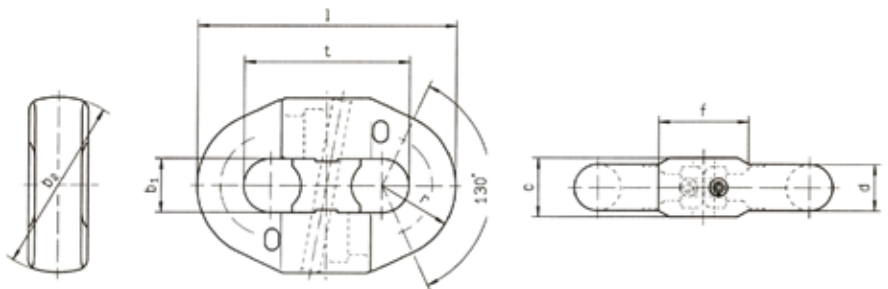

Chain Size d x t [mm]	Article No.	d	t	b ₁ min.	b ₂ max.	c max.	f max.	l max.	r +2	Work Force WF kN max.	Breaking Force kN min.	Weight kg
26 x 92	F26220	26 ± 0,8	92 ± 0,9	28	96	33	62	147	40	531	754	1,8

condition at time of delivery: natural black (NSW)

the above values apply to connectors in 'natural black' condition (NSW)

TKF-Connectors

TWN 0145



The TKF connector has been developed for vertical (round link chains only) and horizontal applications.

The mechanical properties are at least the equivalent of DIN 22258 Part 1.

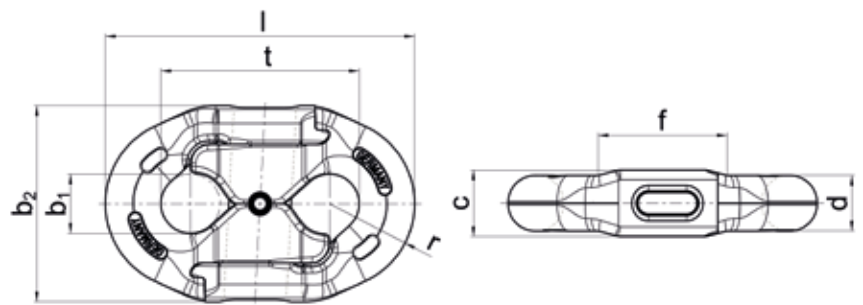

Chain Size d x t [mm]	Article No.	d	t	b ₁ min.	b ₂ max.	c max.	f max.	l max.	r -2	Work Force WF kN max.	Breaking Force kN min.	Weight kg
30 x 108	F26061	30 ± 0,9	108 ± 1,1	32	113	37	72	170	48	707	1.000	2,9
34 x 126	F26071	34 ± 1,0	126 ± 1,3	36	125	41	82	196	54	907	1.290	4,3
38 x 137	F26081	38 ± 1,1	137 ± 1,4	41	138	46	91	216	61	1.130	1.610	6,0

condition at time of delivery: galvanized

the above values apply to connectors in 'natural black' condition (NSW)



DMK-Connectors

TWN 0133

The DMK-Connector has been specially developed as a horizontal connecting link for twin inboard chains.

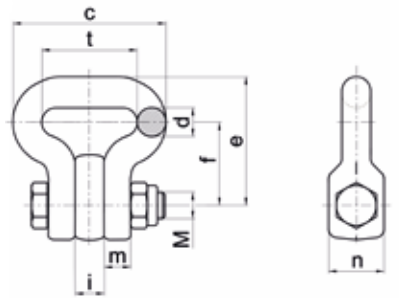

Chain Size d x t [mm]	Art. No.	d	t	c		e	f	i		m	n	Test Force kN	Break. Force kN min.	Bolt Nut	Tight. torque Nm	Weight kg
				min.	max.			max.	max.							
22 x 86	F25211	23,5 ± 0,5	86 ± 1,0	132	117	78	25	24	52	440	550	M24	890	3,3		
26 x 92	F25341	28,0 ± 1,0	92 ± 1,2	146	129	85	28	26	58	580	725	M30	1.775	4,4		
30 x 108	F25401	31,5 ± 1,1	108 ± 1,4	172	147	98	32	31,5	65	725	905	M36	3.082	6,4		

condition at time of delivery: natural black (NSW)

the above values apply to connectors in 'natural black' condition (NSW)

Single Plane (SP) Connectors

TWN 0141

The Single Plane Connector is only suitable for horizontal applications.

The mechanical properties are at least the equivalent of DIN 22258 Part 2.

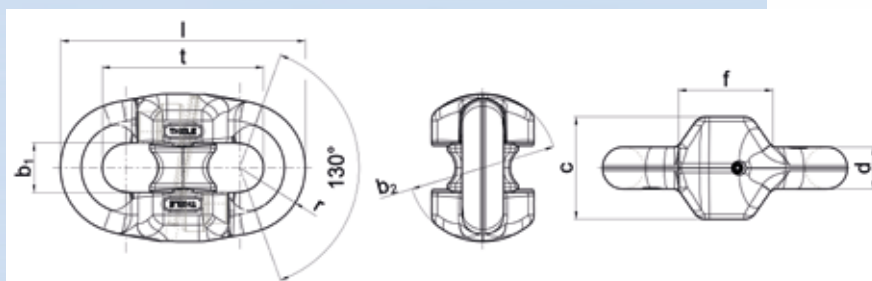

Chain Size d x t [mm]	Article No.	d	t	b ₁		b ₂		c	f	l	r	Work Force WF kN max.	Breaking Force kN min.	Weight kg
				min.	max.	max.	max.							
22 x 86	F26100	22 ± 0,7	86 ± 0,9	24	84	55	53	132	34	380	608	1,5		
26 x 92	F26130	26 ± 0,8	92 ± 0,9	28	96	65	62	146	40	531	850	2,8		
38 x 146	F26165	38 ± 1,1	146 ± 1,5	40	134	95	86	226	59	1.130	1.820	7,8		

condition at time of delivery: natural black (NSW)

the above values apply to connectors in 'natural black' condition (NSW)

SP-S Connectors (Single Plane Screw-Type)

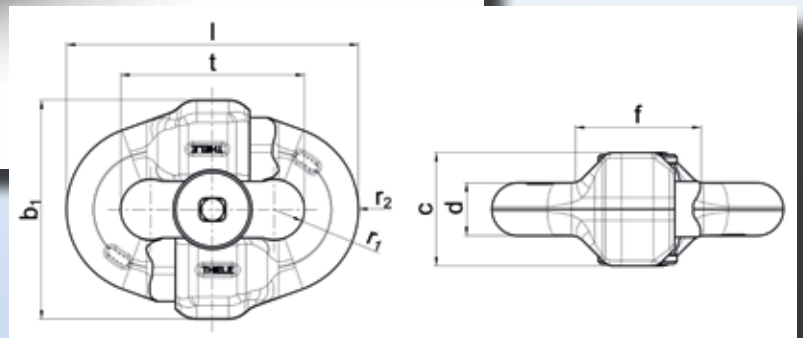

The SP-S Connector is an advanced development of the well proven SP-Connector-Design, with major improvements achieved by incorporating a new center lock that features a bolted connection. The “S” in the name denotes the bolted connection.

New are also the conical contact surfaces which hamper to cake both connector halves and support the disassembly. The new locking system comprises of matching and interconnecting profiles that rotate on the same axis, thereby eliminating the risk of misalignment. This design allows for easy assembly and dismantling.

Chain Size d x t [mm]	Article No.	d	t	r ₁ min.	b ₁ max.	c max.	f max.	l max.	r ₂ -2	Work Force WF kN max.	Breaking Force kN min.	Weight kg
30 x 108	F26142	30 ± 0,9	108 ± 1,1	16,5	111	75	74	172	48	707	1.130	4,2
34 x 126	F26152	34 ± 1,0	126 ± 1,3	18,5	122	85	87	198	55	907	1.450	5,5
34 x 131 BIG-T	F26154	34 ± 1,0	131 ± 1,3	20,0	124	82	71	205	57	907	1.450	5,6
38 x 126	F26166	38 ± 1,1	126 ± 1,3	21,0	137	95	82	207	61	1.130	1.820	7,1
38 x 137	F26162	38 ± 1,1	137 ± 1,4	21,0	137	95	93	218	61	1.130	1.820	7,5
42 x 146	F26172	42 ± 1,3	146 ± 1,5	23,0	181	105	98	235	68	1.380	2.220	10,5
42 x 152 BIG-T	F26177	42 ± 1,3	152 ± 1,5	26,5	179	90	98	241	74	1.380	2.220	12,0

condition at time of delivery: galvanized

the above values apply to connectors in 'natural black' condition (NSW)

Spare Part Set: Center Lock Screw-Type available for all Connector sizes (Article No. Connector +1 - e.g. 30x108 F261421; exception 38x126: F261621)



SP-S Connectors for Power Chain

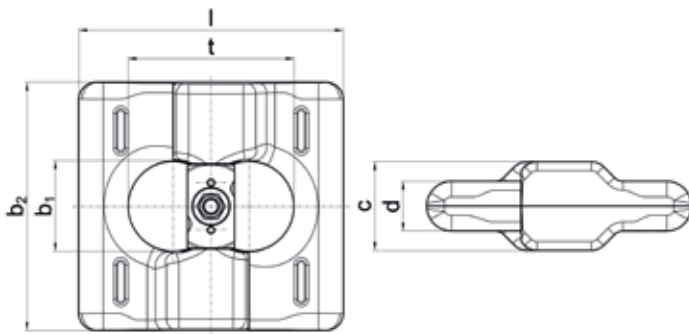

Chain Size d x t [mm]	Article No.	d	t	b ₁ min.	b ₂ max.	l max.	c max.	Breaking Force kN min.	Weight kg
34 x 110	F26257	34	110	37,80	167	178,5	60	1.460	7,8
42 x 140	F26176	42	141	50,25	210	224,5	76	2.220	15,1

condition at time of delivery: galvanized or microzinc

the above values apply to connectors in 'natural black' condition (NSW)

PLOWMASTER®-S

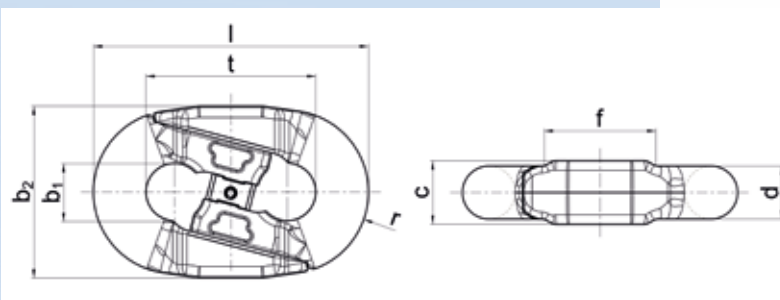

In modern plow systems operated with 42x137 mm round link chains at speeds of over 3,0 m/s, the chain connectors are subject to much higher operational demands. The THIELE PLOWMASTER®-S runs in the shadows of the plow chain, and is therefore protected from the formation of any contact fractures which may otherwise occur as a result of abrasive contact during operation. The screw lock of the PLOWMASTER®-S remain easy to open, even after long runtime.

Chain Size d x t [mm]	Article No.	d	t	b ₁ min.	b ₂ max.	c max.	f max.	l max.	r -2	Breaking Force kN min.	Weight kg
42 x 137	F26274	42	137	45	139	52	91	222	67	1.920	7,0

condition at time of delivery: galvanized

the above values apply to connectors in 'natural black' condition (NSW) Technical change without prior notice!

BLOCKMASTER[®]



ADVANTAGES

- **fast and easy to assemble**
 - extremely short locking movement
 - no chain slack needed
- **bi-directional**
 - installing without regard to the conveying direction
 - no danger of an installation error
- **kink risk free**
 - patented centre stud
- **long life**
 - robust construction

THIELE BLOCKMASTER®

TWN 0147

The THIELE BLOCKMASTER® has been specially developed as a vertical connecting link for Flat Type and DUALINK® Chains. Its mechanical properties are much higher than those specified in DIN 22258 Part 3.

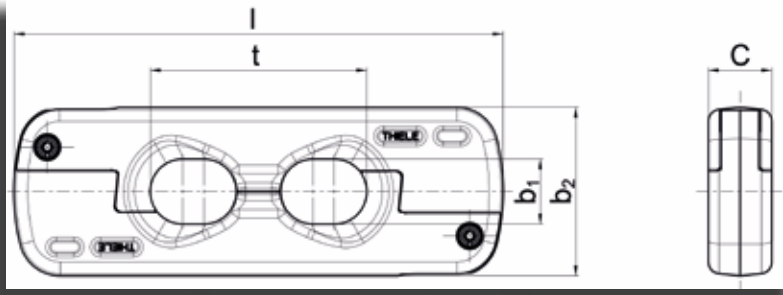

Chain Size d x t [mm]	Article No.	d	t	b ₁ min.	b ₂ max.	l max.	c max.	Breaking Force kN min.	Weight kg	Roll Pins Article No.
34 x 126	F26320	34	126	37	98	283	36	1.600	5,7	Z07862 / Z07863
38 x 126*	F26333	38	126	41	110	273	40	1.820	6,8	Z00448 / Z00083
38 x 137	F26335	38	137	41	110	312	40	2.000	8,1	Z07451 / Z07053
38 x 146	F26330	38	146	41	110	336	40	2.000	8,9	Z07451 / Z07053
42 x 146	F26341	42	146	44	115	334	43,5	2.500	9,8	Z06562 / Z06237
48 x 144/160	F26350	48	144	50	123	356	59	3.100	14,7	Z00302 / Z00303
48 x 152	F263621	48	152	50	128	337	56	2.900	13,4	Z08671 / Z09490

condition at time of delivery: coated RAL5002
*BLOCKMASTER-CP Edition (Central-Pin)

the above values apply to connectors in 'natural black' condition (NSW)

THIELE BLOCKMASTER® for Super Flat Type Chains REINFORCED

The THIELE BLOCKMASTER® has been additionally developed as a vertical connecting link for Super Flat Type Chains REINFORCED.



Chain Size d x t [mm]	Article No.	d	t	b ₁ min.	b ₂ max.	l max.	c max.	Breaking Force kN min.	Weight kg	Roll Pins Article No.
38 x 126*	F263331	38	126	41	101	273	40	1.820	6,4	Z00083 / Z00448
42 x 146*	F26344	42	146	44	108	318	44	2.500	8,4	Z00083 / Z00890
48 x 144/160	F26349	48	144	50	115	333	59	2.900	12,6	Z00916 / Z00303
48 x 152	F26357	48	152	50	116	337	56	2.900	12,4	Z09490 / Z08671
60 x 181**	F26385	60	181	62	136	416,6	68	4.520	21,8	Z09490 / Z08671

condition at time of delivery: coated RAL5002
*BLOCKMASTER-CP Edition (Central-Pin) ** BLOCKMASTER ULTRA 3.1

the above values apply to connectors in 'natural black' condition (NSW)

THIELE BLOCKCHAMPION®

Watch film on
 **YouTube**



THIELE BLOCKCHAMPION®

The THIELE BLOCKCHAMPION® is the state-of-the-art development of the vertical chain connector designed especially for Flat, DUALINK®, Super Flat Type REINFORCED and BIG-T® Chains. A special attribute of BLOCKCHAMPION® is its rounded outer contour, which reduces the diameter of the trajectory on the sprocket in scraper conveyors.

The advantage of the BLOCKCHAMPION® is its extremely easy installation, which becomes of great importance with the increasingly larger diameters of the conveyor chains used.

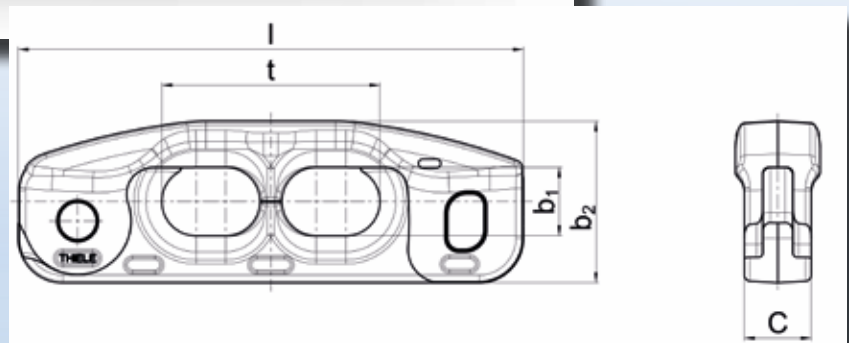

Chain Size d x t [mm]	Chain Type	Article No.	d	t	b ₁ min.	b ₂ max.	l max.	c max.	Breaking Force kN min.	Weight kg	Roll Pins Article No.
34 x 126	Flat/DUA	F26339	34	126	34	98,0	292	36	1.450	5,7	Z00462
38 x 126	Flat	F26347	38	126	41	110,0	289	40	1.820	7,3	Z00462
38 x 137	Flat/DUA	F26343	38	137	41	110,0	321	40	1.820	8,0	Z00462
42 x 146	Flat/DUA/S-Flat	F26354	42	146	45	110,0	341	46	2.500	9,4	Z07862
48 x 152	Flat/DUA	F26364	48	152	50	121,8	345	56	2.900	12,8	Z07862
48 x 152	S-Flat	F263641	48	152	50	116,4	345	56	2.900	12,6	Z07862
52 x 152	BIG-T®	F26372	52	152	57	122,9	378	66,1	3.700	17,0	Z07862
52 x 170	S-Flat	F26373	52	170	55	126,0	387	62	3.400	16,5	Z07862
56 x 187	S-Flat	F26379	56	187	61	132,0	433	65	3.940	21,0	Z00084
60 x 181	S-Flat	on request									
64 x 190	S-Flat	F26380	64	190	69	153,5	502	76	5.147	33,2	Z00084

condition at time of delivery: blue coated RAL 5002

Technical change without prior notice / the above values apply to connectors in 'natural black' condition (NSW)



THIELE flight bar product range

THIELE offers a wide range of flight bars for face conveyors and stage loaders with chain sizes of \varnothing 18 mm - \varnothing 64 mm. All flight bars are drop forged, calibrated and sandblasted. The strength of the bar will depend on the material used. By using a precise heat treatment process THIELE is able to guarantee high notch-impact values at hardness levels of 270-380 HB. THIELE also offers flight bars with induction-hardened tips (page 51) for special operating conditions.

THIELE flight bars are available in a range of different designs:

- | | |
|--|-------------|
| 1. S-Type Flight Bars (symmetrical bars with straps or bows) | pages 45-47 |
| 2. E-Type Flight Bars (split bars) | pages 48-49 |
| 3. Single Strand Flight Bars | page 50 |
| 4. Outboard Flight Bars DIN 22257 | page 52 |



THIELE S-Type Flight Bars with Strap / Bow

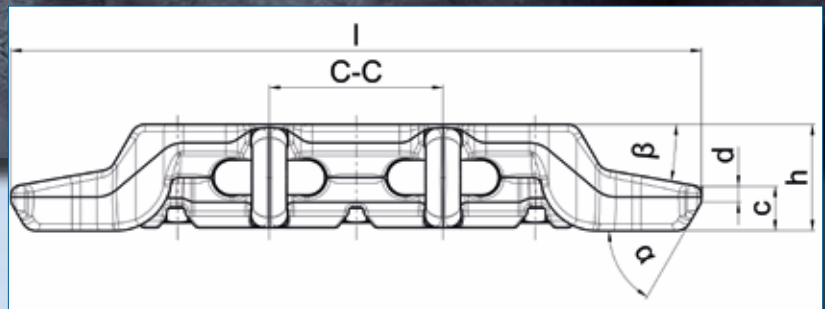
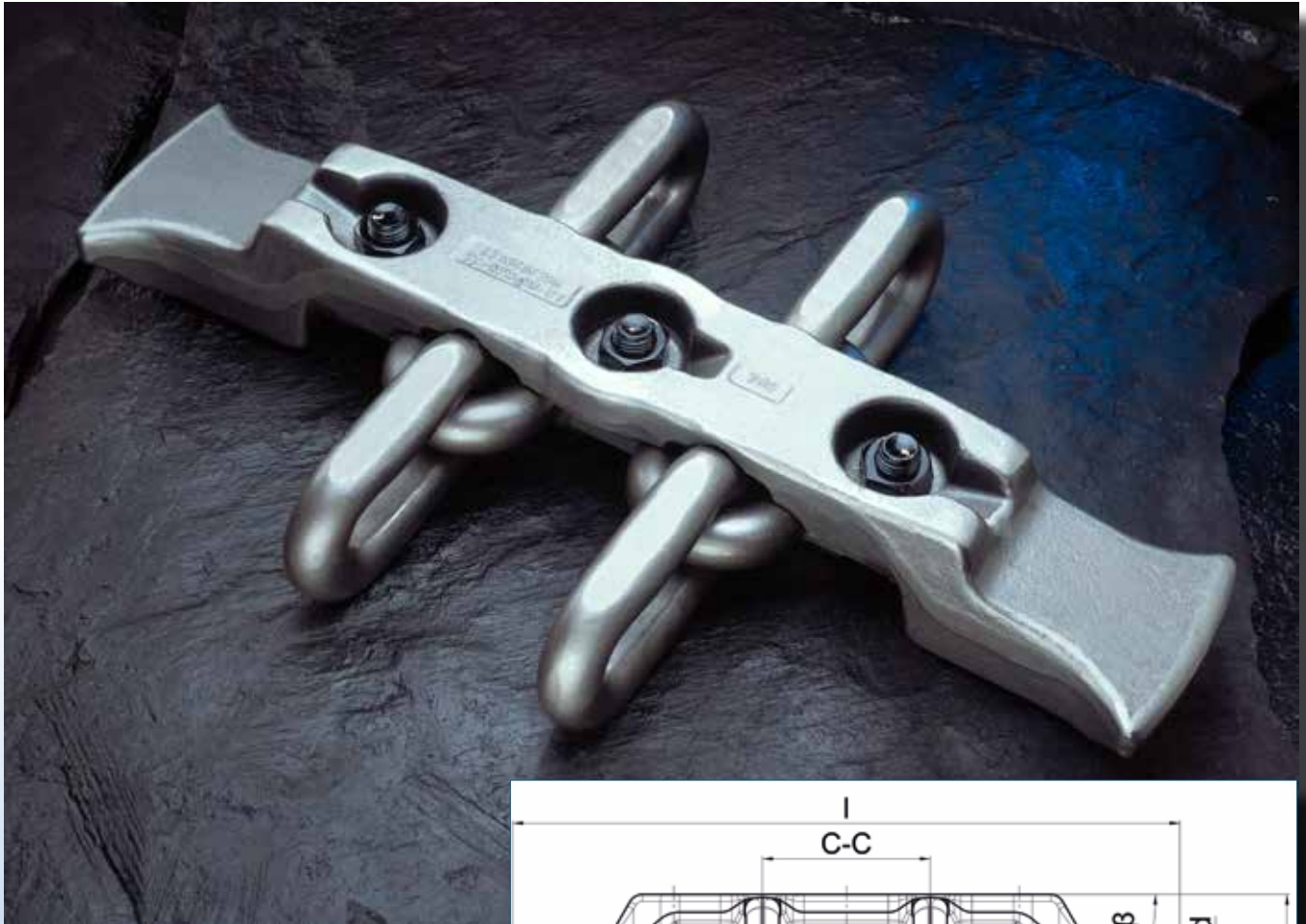

ADVANTAGES

- ⊕ long life time
- ⊕ compatible with original manufacturer's chain sprockets
- ⊕ high flexural strength
- ⊕ can be supplied with hex-head or hammer-head bolts
- ⊕ bi-directional
- ⊕ available with straps (a) or bows (b)

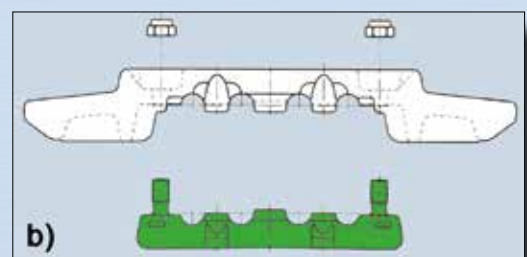
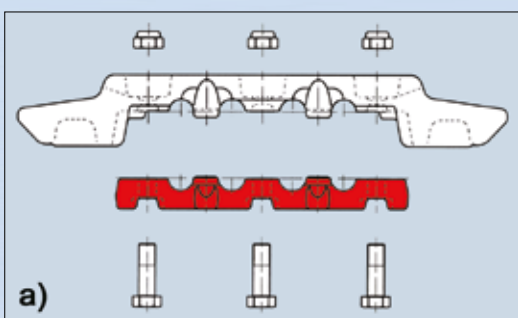

THIELE S-Type Flight Bars with Strap / Bow

Nominal Size	Designation	Art-No. compl.	Art-No. Top Section	Art-No. Strap	G-No.	CC [mm]	l [mm]	h [mm]	c [mm]	d [mm]	α [°]	β [°]	Weight appr. kg
22x86	SK/585/22x86/120	F24340	F24341	F24342	356/357	120	585	75	59,5	15	40	5	16,5
24x86	SK/590/24x86/120	F24345	F243451	F243452	304/305	120	590	81	59,5	15	40	5	17,1
26x92	SK/684/26x92/120	F24351	F243511	F243512	263/273	120	684	100	69	19	47	5	27,3
26x92 Fl.	H205/752/26x92Fl/200	F243523	F243524	F243492	1364/0944	200	752	76	58	25	35	5	23,8
30x108	DMKF3/673/30x108/130	F245060	F245061	F245062	413/414	130	673	101	46	13	30	20	28,4
30x108	HB227/740/30x108/280	F245078	F245079	F245082	1282/930	280	740	101	50	19	30	17	34,0
30x108	PF2.30-832/772/30x108/115	F245087	F245088	F245089	1254/1255	115	772	100	50,5	13	35	19	30,7
30x108	KSD-27/676/30x108/280	F245075	245076	F245082	1431/930	280	676	102	70	21	40	25	31,0
30x108	222/788/30x108/150	F245130	F24513	F245135	1483/1484	150	788	102	64	18	45	9	39,2
30x108 Fl.	E74/583/30x108Fl/200	F245123	F245124	F245122	1266/345	200	583	95	47	14	30	20	21,0
34x126	PF3-822/34x126/150	F24553	F245531	F245532	887/888	150	682	117	57	21	55	19	35,3
34x126	PF4-932/34x126/150	F24556	F245561	F245532	908/888	150	772	114	67	22	55	19	46,7
34x126	PF4-932/34x126/145	F24547	F245471	F245472	778/779	145	772	114	67	22	55	18,5	43,2
34x126	PF2.30-732/34x126/130	F245540	F24554	F245541	251/252	130	676	115	52	17	35	19	39,0
34x126	RY-850/776/34x126/150	F24551	F245511	F245532	253/888	150	776	113	R17,7	-	-	15	40,9
34X126	AM34/784/34X126/170	F24563	F245630	F245631	1053/1054	170	784	114	54	20	60	10	43,7
34x126	OS-900/888/34x126/200	F245455	F245456	F245611	1084/1052	200	888	114	65	14	45	5	48,9
34x126	CM/SPC230/788/34x126/200	F24541	F24540	F245611	1456/1052	200	788	115	54,3	16,5	35	19	46,5
34x126	PF4-1132/976/34x126/130	F24539	F245391	F245542	1239/1240	130	976	115	65	20,5	60	19	57,8
34x126	PF4-832/34x126/130	F245393	F245394	F245542	1263/1240	130	676	115	65	20,5	60	19	40,0
34x126	JQ/1188/34x126/500	F245595	Z10655	F245597	1271/1272	500	1188	122	-	-	-	-	84,3
34x126	222/1142/34x126/375	F245397	Z11292	Z11293	1333/1334	375	1142	115	64	19	45	9	66,2
34x126 Fl.	AM/676/34x126Fl/170	F245392	F2453920	F2453921	1493/1494	170	676	104	43	15	30	10	33,7
34x126 S-Fl.	NW-FFC8/786/34x126S-Fl/170	F24802	F248021	F248022	1444/1445	350	786	92	38	18	50	10	37,2
38x126 Fl.	PF5-1342/38x126/330	F245895	Z09958	F2458951	1133/1134	330	1175	118	65	22	60	20	75,5
38x126 Fl.	PF6-1542/38x126/330	F245898	Z10463	Z10479	1248/1249	330	1375	125	60	19	60	20	87,0
38x126 Fl.	XX/1285/38x126/500	F245897	Z10724	F2458971	1280/1281	500	1285	116	-	-	-	-	82,0
38x126 Fl.	RYB-850/776/38x126/190	F24710	F24711	Z11593	1397/1400	190	776	113	42	-	-	12	44,0
38x126 S-Fl.	JQ/1338/38x126S-Fl/500	F245896	Z11395	F2458971	1365/1281	500	1338	120	-	-	38	38	96,0
38x137 Fl.	JT/788/38x137/200	F24574	F245740	F245761	1039/314	200	788	114	65	14	45	5	41,8
38x137 Fl.	NW/882/38x137/170	F245945	F245946	F255947	1296/1297	170	882	114	50	30	50	9	47,4
38x137 Fl.	AM/784/38x137/200	F245746	F2457460	F245761	1526/0314	200	784	114	64,5	20	45	10	43,9
38x146 Fl.	JLA/787/38x146/180	F24640	F24641	F24642	1403/1404	180	787	118	75	24	45	11	43,9

* Art.-No. bow

all dimensions given exclude forging tolerances

THIELE S-Type Flight Bars with Strap / Bow

Nominal Size	Designation	Art-No. compl.	Art-No. Top Section	Art-No. Strap	G-No.	CC [mm]	l [mm]	h [mm]	c [mm]	d [mm]	α [°]	β [°]	Weight appr. kg
42x146 Fl.	JT/988/42x146/220	F247280	F24728	F247291	075/076	220	988	126	70	20	48	8	64,3
42x146 Fl.	JT/878/42x146/200	F247252	F24725	F247261	708/206	200	878	126	66	20	46	8	52,8
42x146 Fl.	PF6-1142/42x146/165	F246010	F246012	F247311	1129/531	165	976	116	60	16	60	20	60,0
42x146 S-Fl.	PF6-1342/1176/42x146S-Fl/330	F246035	Z10805	F246037	1284/1285	330	1176	125	60	19	60	20	73,0
42x146 Fl.	PF6-1342/42x146/165	F24603	Z10462	F246032	1246/1247	165	1175	125	60	19	60	20	72,0
42x146 Fl.	PF4-1332/42x146/165	F24602	Z06859	F24721*	ZC381/856	165	1170	125	60	18	59	20	74,8
42x146 Fl.	LPT/988/42x146/220	F247320	F24732	F247291	641/076	220	988	122	65	23	41	5	56,6
42x146 Fl.	JT/1088/42x146/220	F247370	Z09298	F247291	352/076	220	1088	126	76	23	45	9	73,0
42x146 Fl.	AM/978/42x146/200	F247287	F247288	F247296	1353/1354	200	978	120	55	20	65	10	54,8
42x146 Fl.	PF6-1542/1375/42x146/330	F246025	F2460250	F246026	1327/1328	330	1375	135	58	23	45	21	102,5
42x146 Fl.	AM-34/784/42x146/200	F247305	F247306	F247307	1380/1381	200	784	116	62	20	60	10	42,0
42x146 S-Fl.	PF6-1042/42x146/165	F247330	F24733	F24731	891/531	165	876	116	60	16	60	20	51,4
48x144-160	PF4-1232/1075/48x144/250	F247735	Z10965	Z10966*	1300/1301	250	1075	135	65	20	60	19	77,7
48x152 Fl.	PF4-1132/975/48x152/250	F24771	F247712	F247707	691/695	250	975	129	64	16	60	20	66,8
48x152 Fl.	268x988/48x152/280	F247722	F247723	F2477011	1183/312	280	988	135	77,5	25	45	10	65,5
48x152 Fl.	222/988/48x152/250	F247705	F2477050	2477071	1267/1268	250	988	135	66	30	36	8	58,0
48x152 S-Fl.	JT/988/48x152S-Fl/280	F24774	F247741	F247743	1389/1390	280	988	126	70	20	45	8	63,9
48x152 S-Fl.	LA/988/48x152S-Fl/250	F247706	F2477071	F247060	1357/1268	250	988	130	62	20	40	6	55,0
48x152 S-Fl.	LM/988/48x152S-Fl/280	F24775	F247745	F247744	1512/1391	280	988	126	68	23	40	6	66,0
52x170 S-Fl.	PF4-1132/975/52x170S-Fl/270	F24801	F248011	F248012	1421/1422	270	975	130	64	16	60	20	64,0
38x126/148 BB	JT/988/38BB/240	F247015	F247016	F247017	1273/1274	240	988	94	51	19	45	11	53,0
38x126/148-BB	222/788/38BB/240	F2470155	F2470156	F2470157	1362/1363	240	788	102	64	19	45	9	40,4
42x128/164-BB	222/888/42BB/280	F246018	F246019	F246017	1279/1235	280	888	109	64	19	45	9	53,0
42x128/164-BB	222/988/42BB/280	F246015	F246016	F246017	1234/1235	280	988	109	64	19	45	9	61,1
42x128/164-BB	NL/988/42BB/280	F246013	F246014	F246017	1361/1235	280	988	109	75	20	45	10	62,8
42x128/164-BB	JQ/1338/42BB/500	F247202	F247200	F247201	1527/1524	500	1338	123	-	-	38	-	109,8
50x146/174-BB	222U/988/50BB/280	F247855	F2478551	F2478552	1310/1311	280	988	136	77,3	26	45	9	70,0
50x146/174-BB	222H/988/50BB/280	F247853	F247853	F247852	1391/1244	280	988	126	64	16	45	10	73,9
42x140 BIG-T	222/1282/42BIG-T/500	F246033	F2460330	F2460331	1336/1337	500	1282	125	64	19	45	9	86,0
42x140 BIG-T	JQ/1388/42BIG-T/500	F246034	F2460340	F2460331	1521/1337	500	1338	123	-	-	38	-	107,2
42x140 BIG-T	LM/1282/42BIG-T/360	F246031	F2460310	F2460311	1513/1514	360	1282	114	56	19	60	6	88,2
52x152 BIG-T	222/988/52BIG-T/280	F247910	F247909	F247908	1475/1478	280	988	126	64	16	45	10	74,4

* Art.-No. bow

all dimensions given exclude forging tolerances

THIELE E-Type (Split) Flight Bars



ADVANTAGES

- + low unit weight makes for easy handling
- + can be fitted with chain still under tension
- + compatible with original manufacturer's chain sprockets
- + calibrated chain recess

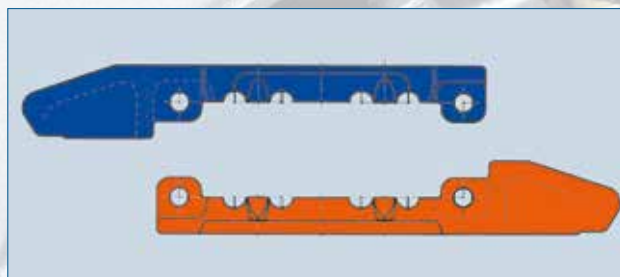

THIELE E-Type (Split) Flight Bars

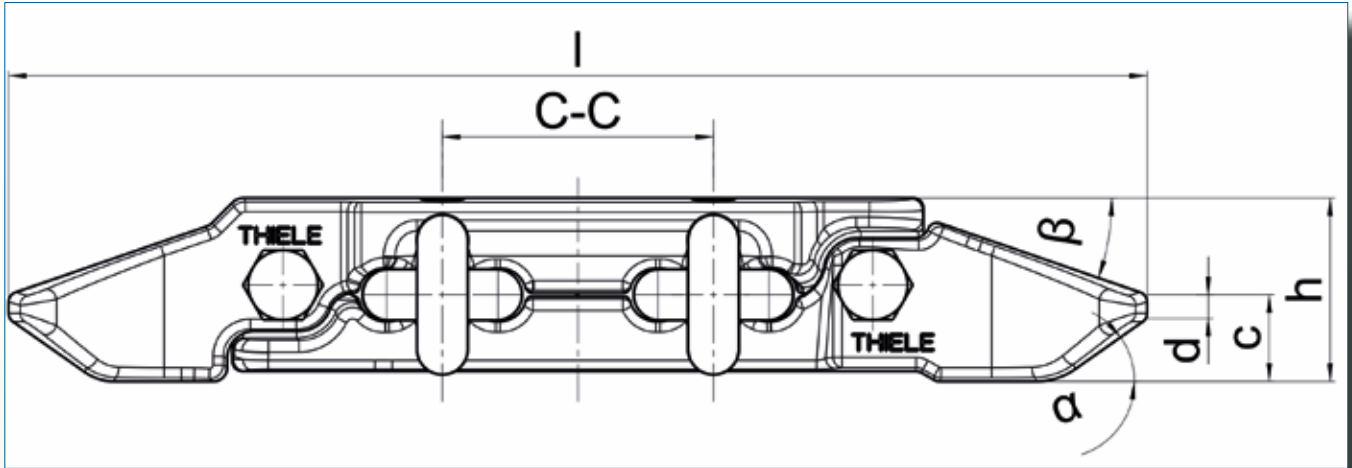

Nominal Size	Designation	Art-No. complete	Art-No. Top Section	Art-No. Bottom Section	G-No.	CC [mm]	l [mm]	h [mm]	c [mm]	d [mm]	α [°]	β [°]	Weight appr. kg
34x126	JR-800/788/34x126/200	F245600*	H2456107	H2456007	965/966	200	788	114	52	16	35	19	42,1
34x126	NW-FSL10/1012/34x126/375	F24487	H244891	H244892	1454/1455	375	1012	114	49	23	55	10	60,4
34x126	JQ-1200/1188/34x126/500	F24571**	-	-	FC905/FC906	500	1187	122	-	-	30x45°	30x45°	80,8
34x126	E260/RV-750/690/34x126/150	F24559	H245591	H245592	1500/1501	150	690	114	43	-	-	12	55,6
38x137 Fl	NW-FFC9/888/38x137/FL/200	F245770	H2457701	H2457702	1528/1529	200	888	114	46	-	50	10	50,2

* Art. No. without screws and bolts ** Art. No. for Huck-Bolts

all dimensions given exclude forging tolerances



THIELE Single Strand Flight Bar

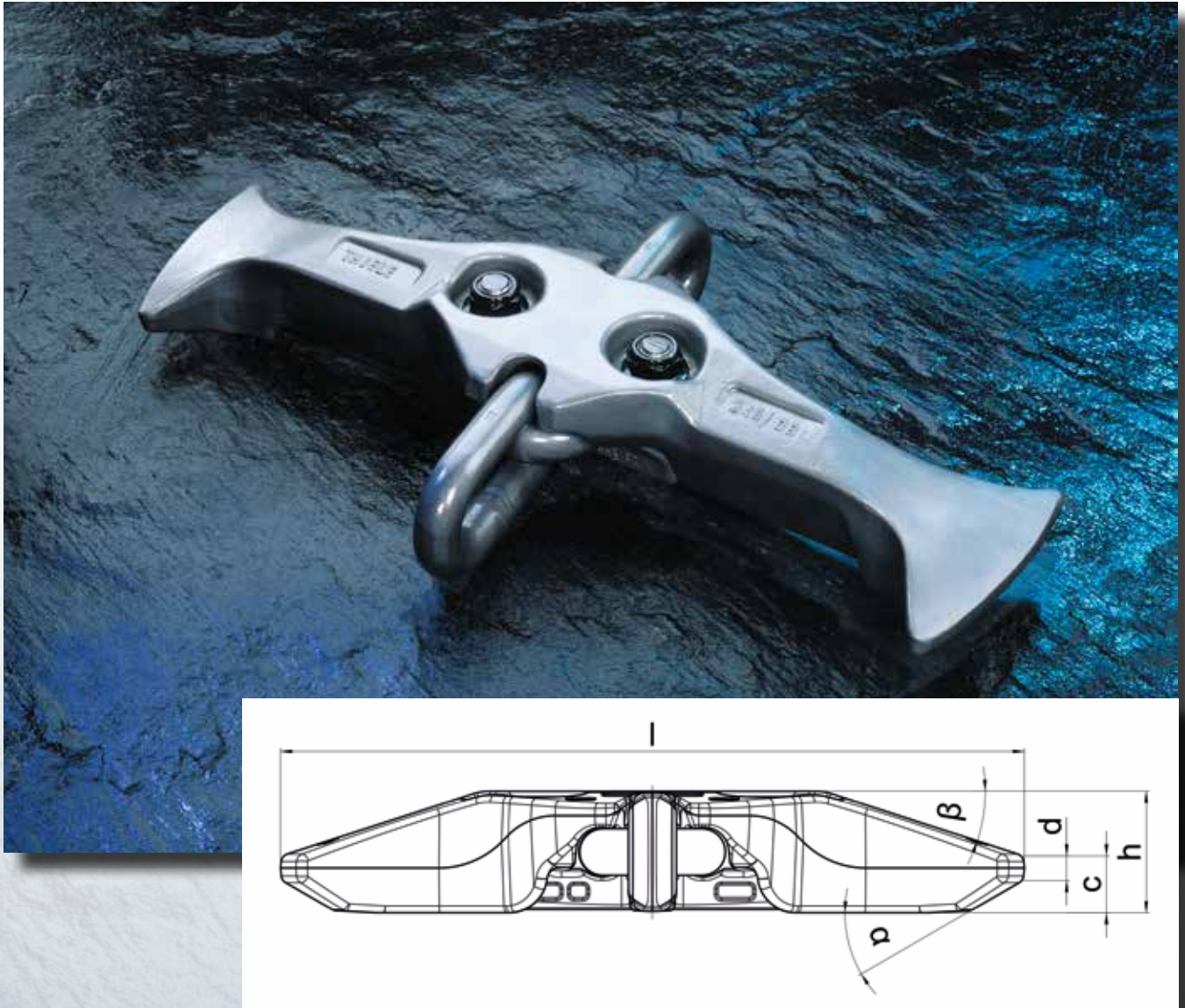

THIELE Single Strand Flight Bars are designed for single-strand chain conveyors. The accurately forged and calibrated chain recess ensures a smooth chain run and prevents the flight bar from wandering out of the pan profile.

Nominal Size	Designation	Art-No. complete	Art-No. Top Section	Art-No. Bow	G-No.	l	h	c	d	α	β	Weight
						[mm]	[mm]	[mm]	[mm]	[°]	[°]	appr. kg
26x92	EKF2-26	F243600	F24360	F25662	R0248/723	576	90	40	13,5	30	20	16,1
30x108	EKF3-30	F24516	F24515	F25720	704/231	676	96	39	16,0	30	20	22,1
34x126	EKF34/776	F24536	F245361	F25821	Z0831/935	772	105	52	18,0	34	20	33,3
34x126	EKF34/676	F24537	F245371	F25821	Z0876/935	676	105	47	13,5	30	20	29,1
42x146	EKF42/674	F245340	F245343	F245342	1312/1313	674	110	51	21,0	30	18	34,3
48x152	EKF48x152/914	F24533	F245331	Z11216	1329/1330	914	122	82	35,0	42	12	59,7

all dimensions given exclude forging tolerances

Induction-hardened tips

For highly abrasive operating conditions - with a high rock content in the conveyed material - THIELE offer flight bars with induction hardened tips. This induction hardening process increases the hardness up to 55 HRC.

Such a measure reduces the wear rate of the tips and extends the operating life of the flight bars. The hardening of the tips does not increase the wear of the panline sigma profile as much as it is often suspected. The wear at the sigma-profile is mainly driven by the abrasiveness of the conveyed product, the hardness of the flightbar tips has only a very small influence on the sigma section wear. The continuous hardening profile over the top and bottom of the tip provides an even wear pattern, which in return reduces the formation of chain grooves and other uneven wear.

Typically for extremely abrasive conditions the overall cost savings realized with tip-hardened flight bars outweigh the higher cost associated with pan line wear. For less abrasive operating conditions THIELE offer mild tip hardening in the range of 39,6 - 44,1 HRC.

The hardness specification of the tip hardening (surface hardness and hardness depth) is tested in the THIELE laboratory at 5 defined points of the tips.

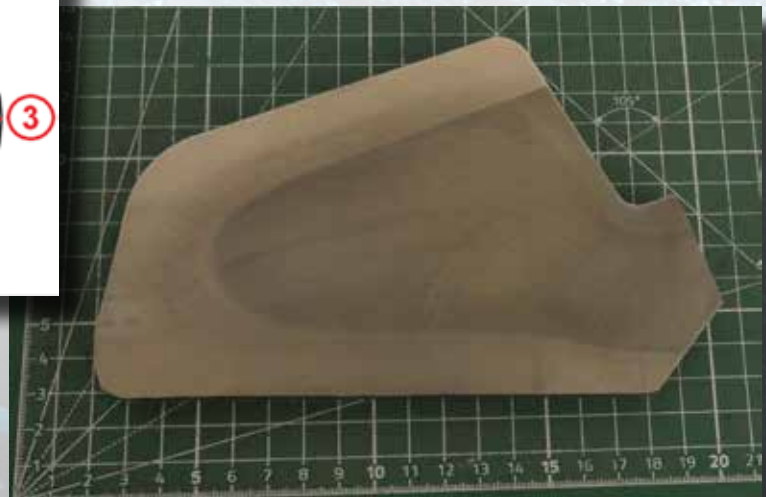
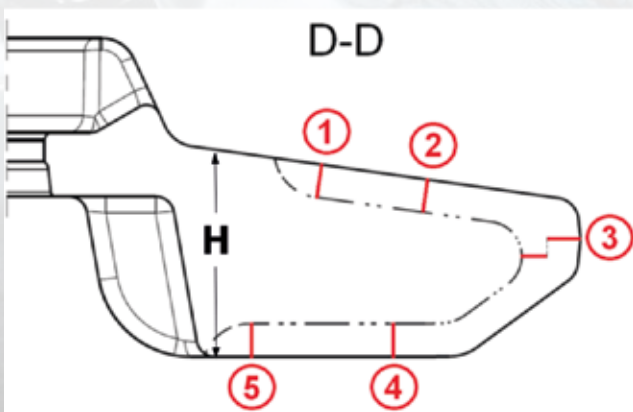

Designation	Material No.	Surface Hardness		Hardening Depth DS [mm]		Limit Hardness [HV10]	
		[HV10]	[HRC]	min.	max.		
CTH	Classic Tip Hardening	1.7225	540 - 600	51,8 - 55,1	14	0,3 x H	432
GTH	Great Tip Hardening	1.7225	450 - 510	45,7 - 49,9	14	0,3 x H	360
MTH	Mild Tip Hardening	1.7225	380 - 430	39,6 - 44,1	14	0,3 x H	304
STH	Super Tip Hardening	1.6758	450 - 510	45,7 - 49,9	14	0,3 x H	360

Further details are specified in THIELE-TWN 0165.

Outboard chain assemblies

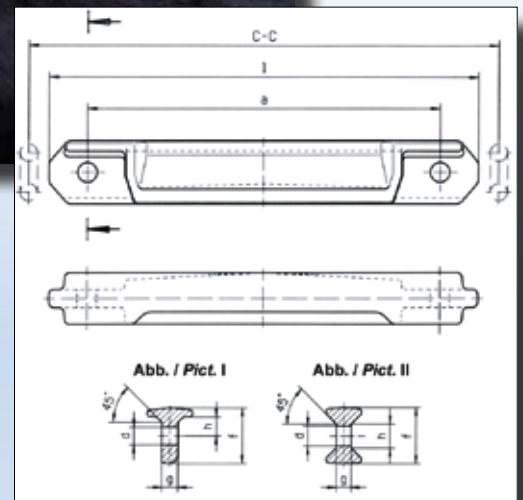

THIELE outboard chain assemblies are available for the following chain sizes: 18x64, 19x64,5, 22x86, 24x86 and 26x92 mm. All flight bars are forged and sandblasted and feature drilled holes. The tensile strength of the material after heat treatment is 270-320 HB. Chain connectors for outboard chain assemblies are manufactured according to DIN 22253 specifications.

Outboard flight bars DIN 22257

Nominal Size	Conveyor	Art-No.	CC [mm]	Pict.	l [mm]	a [mm]	d [mm]	f [mm]	g [mm]	h [mm]	Weight appr. kg
18x64/19x64,5	PFI-500	F24110	500	I	440	390	21,5	63	19,0	21,5	7,8
18x64/19x64,5	PFI-650 U*	F24260	650	I	590	540	21,5	63	19,0	21,5	10,7
22x86	PFII-600	F24211	600	I	548	450	25	80	23,0	26,5	13,8
24x86	PFII-600 SP301*	F24208	600	II	507	444	25	87	24,0	37,0	13,7
24x86	PFII-600*	F24210	600	I	542	444	26	77	25,0	26,0	13,4
26x92	PFIII-600	F24200	600	I	530,4	428,8	28	94	26,5	29,5	18,0

* not according to DIN 22257 specifications

all dimensions given exclude forging tolerances

Outboard chain connectors DIN 22253*

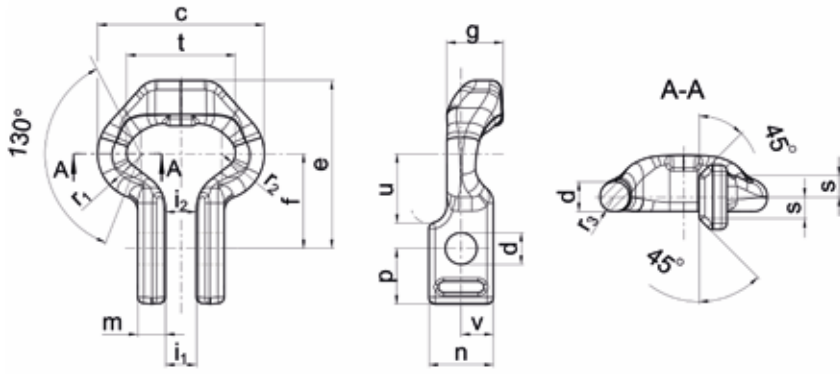

Nominal Size	Art-No.**	t	b	c	d	e	f	g	i ₁	i ₂	m	n	p ₀ ⁺¹	r ₁	r ₂	s	u	v	Wei. kg			
14x50	F25001	50,0	^{+0,8} _{-0,3}	14,8	^{+0,9} _{-0,3}	79 ± 1,0	17	^{+0,5} ₀	78	51	29	17,5	^{+1,5} ₀	14,2	31,3	19	23	8	10,5	29	16,7	0,54
18x64	F25080	64,0	^{+0,9} _{-0,3}	19	^{+1,0} _{-0,5}	101 ± 1,0	21	^{+0,5} ₀	100	55	40	20,5	^{+1,5} ₀	18,5	42	37	29	10	14,5	38	21,0	1,28
18x64***	F25082	64,0	^{+0,9} _{-0,3}	19	^{+1,0} _{-0,5}	101 ± 1,0	21	^{+0,5} ₀	103	58	40	20,5	^{+1,5} ₀	18,5	42	37	29	10	14,5	38	21,0	1,30
19x64,5	F25151	64,5	^{+0,9} _{-0,3}	20	^{+1,0} _{-0,5}	105 ± 1,0	21	^{+0,5} ₀	100	55	41	20,5	^{+1,5} ₀	19	43	37	30	10	14,5	38	21,5	1,50
22x86	F25201	86,0	^{+1,3} _{-0,4}	23	^{+1,0} _{-0,5}	132 ± 2,0	25	⁺¹ ₀	133	75	44,6	24,5	^{+1,5} ₀	22,5	51	44	36	12	17,0	51	25,5	2,50
24x86***	F25260	86,0	± 1,0	26	^{+1,5} _{-1,0}	138 ± 1,1	27	^{+0,5} ₀	126	78	52	25,5	^{+1,5} ₀	24,5	52	44	40	14	17,8	50	26,0	2,70
24x86***	F25265	86,0	± 1,0	26	^{+1,5} _{-1,0}	138 ± 1,1	27	± 0,5	133	78	43	25,5	^{+1,5} ₀	24,5	52	44	39	13	17,8	50	26,0	2,70
26x92	F25310	92,0	± 0,9	27	^{+1,0} _{-0,5}	146 ± 2,0	28	⁺¹ ₀	141	85	56	28,0	⁺² ₀	26	58	42	42	14	19,0	56	28,0	3,45
26x92***	F253161	92,0	± 0,9	28	± 0,5	148 ± 1,4	28	^{+0,5} ₀	154	91	53	32,0	⁺¹ ₀	27	53	41	42	14	---	62	26,5	3,10
30x108***	F253981	108,0	± 1,0	31	^{+1,0} _{-0,5}	170 ± 2,0	31	^{+0,5} ₀	168	105	58	32,5	^{+1,5} ₀	30	59	65	48	17	---	79	29,5	5,10

* DIN22253:1987; ** Art. no. only for bow; *** Note: these dimensions do not conform to DIN 22253:1987; condition at time of delivery: natural black (NSW)

Nominal Size d x t [mm]	Art.-No. ****	Hex-head bolt		Hex-head nut DIN 985			Work Force WF kN max.	Breaking Force kN min.	Weight kg
		Thread	Class	Thread	Class	Torque			
14x50	F25008	M16x65	8.8	M16	10	264 Nm	154	190	0,68
18x64	F25085	M20x90	10.9	M20	10	517 Nm	254	351	1,68
18x64***	F25086	M20x83	10.9	M20	10	517 Nm	254	351	1,68
19x64,5	F25158	M20x90	10.9	M20	10	517 Nm	283	391	1,52
22x86	F25204	M24x98	10.9	M24	10	890 Nm	380	525	3,00
24x86***	F25261	M24x105	10.9	M24	10	890 Nm	452	588	3,51
24x86***	F25266	M24x105	10.9	M24	10	890 Nm	452	588	3,21
26x92	F25311	M27x115	10.9	M27	10	1304 Nm	531	690	4,21
26x92***	F25316	M27x120	10.9	M27	10	1304 Nm	531	690	3,85
30x108***	F25398	M30x130	10.9	M30	10	1775 Nm	707	869	6,20

**** Art. no. for complete connector incl. nut and bolt; ** Note: these dimensions do not conform to DIN 22253:1987; the above values apply to connectors in 'natural black' condition (NSW)

THIELE Sprocket Rings / Assemblies

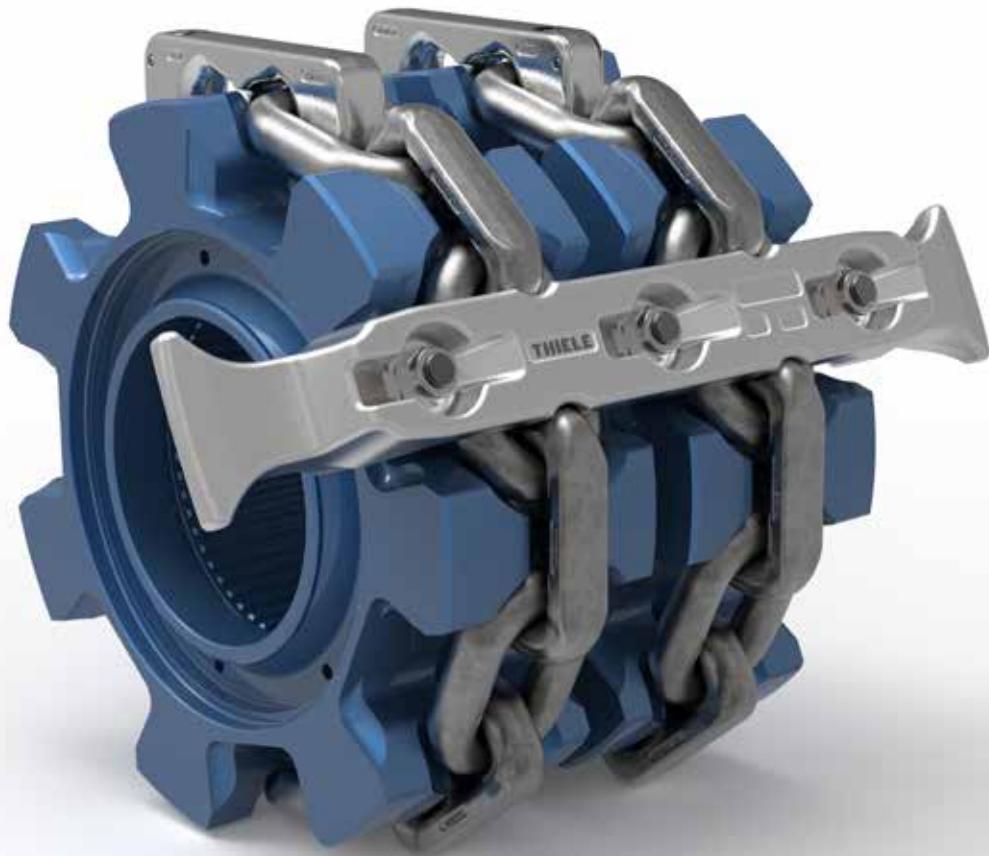

Since 2015 THIELE have been able to manufacture all moving components of a chain conveyor.

As a single supplier of the conveyor system this ensures chains, connectors, flight bars and sprockets are perfectly matched.

All design and product development are carried out in-house using the latest 3D CAD systems. The complete spectrum of sprocket and sprocket assemblies is covered, which is used in modern face conveyors and stage loaders.

THIELE look back on more than 100 years of experience in the production of conveyor sprockets.



THIELE Sprocket Rings / Assemblies



The experience of numerous operations led to the development of a special TD tooth geometry of the pocket. Such a tooth contour reduces the surface pressure along the contact area. This slows the overall wear and results in a reduction of the formation of outer wear marks in the crowns of the chain links (often called “duck tails”).

The power transmission runs via a keyway or an internal spline. Regardless of whether a solid sprocket or a split sprocket design is implemented the DIN22256 quality requirements are guaranteed and often exceeded.

A material composition selected for underground conditions allows inductive surface hardening of the sprocket pockets of up to 56 – 60 HRC at hardness depths greater than 20 mm.

Our production is carried out by advanced CNC machines that not only cater for all current sizes but can also cater for future nominal sizes above 60 mm.

Our product range is complemented by assembled drive units and non-driven return ends, which are fully compatible with the given machine frames.

This allows conveyors to be converted or upgraded according to customers’ requirements.

Our expert and experienced design engineers are available for all tasks no matter how challenging to create customized solutions.

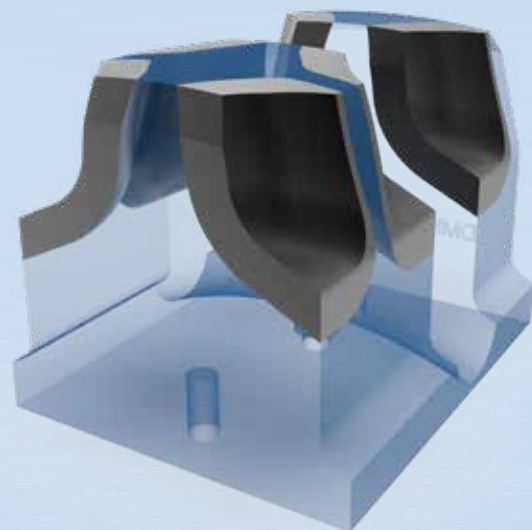



THIELE Sprocket Rings / Assemblies

Nominal Size	Teeth No.	Pitch Circle	Groove root diameter		Overlay height	Groove width	Tip circle diameter	
			Flat Type	Round Link				
d x t [mm]	z	d ₂ [mm]	d ₃ max. [mm]		s ± 0,5 [mm]	b ± 1 [mm]	[mm]	
26	92	4	242,0	142,9	232,9	92,2	34,5	281
26	92	5	299,0	201,6	291,6	123,8	34,5	338
26	92	6	356,5	260,3	350,3	154,7	34,5	395
26	92	7	414,3	319,0	409,0	185,1	34,5	453
26	92	8	472,3	377,7	467,7	215,2	34,5	511
30	108	4	284,1	168,8	273,2	108,7	39,1	329
30	108	5	350,9	237,7	342,1	145,8	39,1	396
30	108	6	418,4	306,7	411,1	182,0	39,1	463
30	108	7	486,3	375,6	480,0	217,7	39,1	531
30	108	8	554,4	444,5	548,9	253,0	39,1	599
34	126	5	409,3	281,2	398,8	170,9	43,7	460
34	126	6	488,1	361,7	479,3	213,1	43,7	539
34	126	7	567,3	442,2	559,8	254,6	43,7	618
38	126	5	409,7	266,9	400,1	168,2	48,3	467
38	126	6	488,4	347,2	480,4	210,5	48,3	545
38	126	7	567,6	427,5	560,7	252,2	48,3	625
38	137	5	445,1	300,8	434,0	185,1	48,3	502
38	137	6	530,8	388,3	521,5	231,1	48,3	588
38	137	7	616,9	475,7	608,9	276,3	48,3	674
38	146	5	474,2	328,5	461,7	199,0	48,3	531
38	146	6	565,5	421,9	555,1	247,8	48,3	622
38	146	7	657,3	515,1	648,3	296,0	48,3	714
42	146	5	474,5	325,0	463,0	196,3	52,3	538
42	146	6	565,8	418,1	556,1	245,3	52,3	629
42	146	7	657,5	511,3	649,3	293,5	52,3	721
48	152	5	494,5	332,2		201,6	64,4	566
48	152	6	589,4	428,9		252,7	64,4	661
48	152	7	684,9	525,7		303,0	64,4	757
52	170	5	552,8	388,9		226,7	71,3	631
52	170	6	659,0	497,2		283,8	71,3	737
52	170	7	765,8	605,5		340,0	71,3	844
56	187	5	608,0	435,3		250,2	75,3	692
56	187	6	724,8	554,5		312,9	75,3	809
56	187	7	842,3	673,7		374,8	75,3	926
60	189	5	614,9	438,0		250,6	80,5	705
60	189	6	732,9	558,2		314,1	80,5	823
60	189	7	851,6	678,6		376,7	80,5	942
64	210	5	682,9	482,9		280,3	87,4	779
64	210	6	814,1	616,7		350,8	87,4	910
64	210	7	946,0	750,5		420,2	87,4	1042

THIELE cardan chains



Example: Cardan Chain F82048
 p_1 2 7/8" / p_2 3 1/8", Flight Bar 740 mm

Cardan chains with universal joints are able to move in all directions and are designed for use with high-speed conveyors (> 1 m/s) operating on tunnelling and roadheading machines.

THIELE cardan chains offer unbeatable ductility and wear resistance as a result of optimised heat treatment and the use high-quality materials.

TM-Chain Block TWN 1000

TM-Lever Block TWN 1001



Specifications

- ⊕ with Overload Protection*
- ⊕ Lightweight robust steel construction
- ⊕ THIELE alloy load chain according to the DIN EN 818-7-T
- ⊕ Minimized headroom
- ⊕ Minimum effort to raise maximum load
- ⊕ Hooks with strong casted safety latches
- ⊕ Approved for tensioning according to the DIN EN 12195-3 (TM Lever Blocks only)
- ⊕ Fully enclosed gear train (TM Chain Blocks only)
- ⊕ Protected automatic weston brake with unique twin pawls
- ⊕ Galvanized hand chains (TM Chain Blocks only)
- ⊕ Corrosion protection of galvanized load chain
- ⊕ Durable baked enamel paint protection
- ⊕ Standard spare parts available
- ⊕ TÜV / GS / CE approved
- ⊕ Supplied with THIELE test certificates
- ⊕ Manuals available in 5 languages



TWN 1000
TM-Chain Block
 Capacities
 500 kg to 5 tonnes



TWN 1001
TM-Lever Block
 Capacities 250 kgs*
 to 6 tonnes

Advantages of the overload protection at TM-Series:

- ⊕ Protects the operator from injury
- ⊕ Protects the hoists from damages
- ⊕ Extends the service life compared to no overload protection devices
- ⊕ Complies with the DIN EN 13157, DGUV 54 und GPSG

* Except TM-LB 025 Lever Block

TM-Chain Block TWN 1000

The TM chain blocks TWN 1000 are handoperated portable devices for pulling, lifting and moving of loads. The integrated slipping clutch works as an overload protection. The galvanized THIELE-load chains TWN 0062 comply with the requirements of the DIN EN 818-7.

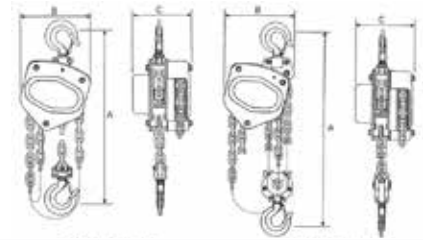

	unit	TM-B-OP 05N	TM-B-OP 10N	TM-B-OP 20N	TM-B-OP 30N	TM-B-OP 50N
Working Load Limit	[t] max.	0,5	1,0	2,0	3,0	5,0
Lift app. 3,05 m (10 ft.)	[Art.-No.]	F063511	F063611	F063711	F063811	F063911
Lift app. 4,60 m (15 ft.)	[Art.-No.]	F063512	F063612	F063712	F063812	F063912
Lift app. 6,10 m (20 ft.)	[Art.-No.]	F063513	F063613	F063713	F063813	F063913
Lift app. 9,10 m (30 ft.)	[Art.-No.]	F063514	F063614	F063714	F063814	F063914
Lift app. 12,20 m (40 ft.)	[Art.-No.]	F063515	F063615	F063715	F063815	F063915
Chain strands	[pieces]	1	1	1	2	2
Effort to lift for max. Working Load	[kgs] max.	23	30	35	27	41
Load chain diameter	[mm]	6	6	8	8	10
Headroom (A)	[mm]	270	317	414	465	636
Width (B)	[mm]	127	158	187	210	288
Depth (C)	[mm]	131	140	161	161	190
Hook opening (top)	[mm]	36	42	46	54	64
Hook opening (bottom)	[mm]	36	42	46	54	64
Net weight (for lift 3,00 m)	[kgs]	13,63	16,03	23,76	29,96	28,6
Chain Block only	[Art.-No.]	F06353	F06363	F06373	F06383	F06393

TM-Lever Block TWN 1001

The TM lever blocks TWN 1001 are hand operated portable devices for pulling, lifting and moving of loads. They can also be used as lashing devices in accordance to the DIN EN 12195-3. The integrated slipping clutch works as an overload protection. The galvanized THIELE-load chains TWN 0062 comply with the requirements of the DIN EN 818-7.

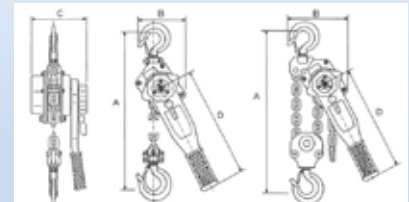

	unit	TM-LB 025*	TM-LB-OP 075N	TM-LB-OP 150N	TM-LB-OP 300N	TM-LB-OP 600N
Working Load Limit (Lashing Capacity)	[t] max.	0,25	0,75	1,5	3	6
Lift app. 1,50 m (5 ft.)	[Art.-No.]	F061901	F062411	F062511	F062611	F062711
Lift app. 3,05 m (10 ft.)	[Art.-No.]	F061902	F062412	F062512	F062612	F062712
Lift app. 4,60 m (15 ft.)	[Art.-No.]	F061903	F062413	F062513	F062613	F062713
Lift app. 6,10 m (20 ft.)	[Art.-No.]	F061904	F062414	F062514	F062614	F062714
Chain strands	[pieces]	1	1	1	1	2
Effort to lift for max. Working Load	[kgs] max.	2,5	14	22	32	34
Load chain diameter	[mm]	4	6	8	10	10
Length of lever handle (D)	[mm]	160	280	410	410	410
Headroom (A)	[mm]	230	325	380	480	620
Width (B)	[mm]	85	136	160	180	235
Depth (C)	[mm]	92	148	172	200	200
Hook opening (top)	[mm]	25	42	46	54	62
Hook opening (bottom)	[mm]	25	42	46	54	62
Net weight (for lift 1,50 m)	[kgs]	2,37	7,1	13,2	21,75	32,97
Lever Block only	[Art.-No.]	F06192	F06243	F06253	F06263	F06273

* TM-LB 025 5 without overload protection



Accessories: chain gauge



Measuring chain length is a useful way to assess the condition of the chain and determine the optimum maintenance routine (chain management).

Basic kit	Art. No.
Shatterproof and waterproof plastic case	Z08606
Leather pouch	Z08881
Gauge tool – sliding arm with scale	Z08879
Gauge tool – fixed arm	Z08880
Allen key 3 mm	Z08915
Wrench 6 mm	Z08916

Adapter	Art. No.
Pitch P = 64 mm	Z08868
Pitch P = 86 mm	Z08869
Pitch P = 92 mm	Z08870
Pitch P = 108 mm	Z08871
Pitch P = 126 mm	Z08872
Pitch P = 126 mm Longvers. 8xp	Z10310
Pitch P = 137 mm	Z08873
Pitch P = 146 mm	Z08874
Pitch P = 152 mm ; 144/160 mm	Z08875
Pitch P = 170 mm	Z11179
Pitch P = 187 mm	Z11546
Pitch P = 189 mm	Z10168
for Broadband 38 mm	Z09385
for Broadband 42 mm	Z09395
for Broadband 50 mm / BIG-T 52 mm	Z08876
for Broadband 56 mm	Z10167
for Broadband 60 mm	Z10663
for Power Chain 34 mm	Z08878
for Power Chain 42 mm	Z08866



additional adapter pieces available on request

Accessories: chain saws



THIELE supplies pneumatic and hydraulic saws for use underground. These can be employed not only as chain saws but also for cutting other items such as pipes and roadway supports up to a diameter of 180 mm.

Air Band Saws

Art.-No.	Cutting Capacity ∅	Cutting Capacity □	Power	Air consumption	Overall length	Height incl. Motor	Width	Air Connection	Hose ID	Housing Material	sound pressure level	vibration value	weight
	mm	mm	kW	m ³ /min	mm	mm	mm		mm		dB(A)	m/s ²	kg
Z10318 (6003)	115	115x120	0,5	0,55	550	240	220	R1/4"i	7	Alu	86,8	<2,5	6,2
Z08352 (6030)	107	107x120	0,7	0,9	550	240	210	R1/2"i	13	E-Stahl	76,3	<2,5	9,5
Z09521 (6032)	120	120x180	0,7	0,9	630	240	220	R1/2"i	13	E-Stahl	76,3	<2,5	9,9
Z07823 (6031)	180	180x180	1,0	1,2	730	290	285	R1/2"i	13	E-Stahl	81,7	<2,5	13,0

Technical changes without prior notice

Performance data for operating pressure of 6 bar

Hydraulic Band Saws

Art.-Nr.	Cutting Capacity ∅	Cutting Capacity □	Power	Operating pressure	Oil flow	Quick Coupling	Overall Length	Housing Material	sound pressure level	vibration value	weight
	mm	mm	kW	bar	l/min	mm	mm		dB(A)	m/s ²	kg
Z10206 (6043)	107	107x120	1,5	140	15-50	1/2" FF	550	E-Stahl	81,7	2,6	10,0
Z10228 (6042)	120	120x180	1,5	140	15-50	1/2" FF	630	E-Stahl	81,4	2,8	10,4
Z08368 (6041)	180	180x180	1,5	140	12-50	1/2" FF	730	E-Stahl	81,7	2,7	13,5
Z10229 (6054)	180	180x240	1,5	140	12-50	1/2" FF	838	E-Stahl	81,5	2,7	16,1

Technical changes without prior notice

Performance data for operating pressure of 140 bar

Accessories: pretensometer



Correct chain pretension is essential not only to ensure troublefree conveying and a safe working environment but also to help extend the service life of the chain and sprockets.

THIELE can supply a full range of pretensometers for chains of \varnothing 26 – 50 mm.

Pretensometer for chain	Art. No.	Weight approx. kg
26 x 92	Z08008	50
30 x 108	Z08946	52
34 x 126	Z08947	54
38 x 126	Z10424	54
38 x 137	Z08984	55
42 x 137	Z10426	86
42 x 146	Z08985	87
48 x 144/160	Z10425	90
48 x 152	Z08986	90
Broadband 42x128/164	Z10423	93
Broadband 50x146/174	Z10018	98

Operating Instructions Mining

Operating Instructions Mining for conveyor chains, plough chains and chain gauge are available in the following languages:

- German
- English
- Spanish
- Polish
- Russian
- Chinese

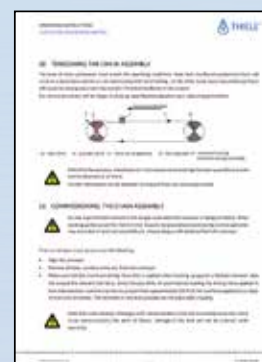

How to find us



Navigation to THIELE:

Werkstr. 3, 58640 Iserlohn-Kalthof

Follow us on



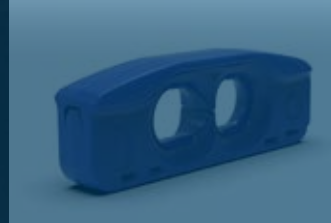

THIELE GmbH & Co. KG

Werkstr. 3
58640 Iserlohn - Kalthof
Germany

Phone +49 23 71 9 47 - 0
Fax +49 23 71 9 47 - 267
Internet www.thiele.de
eMail mining@thiele.de

CHANGE[®]
for Success